

ECP200 EXPERT



Use and maintenance manual

READ AND KEEP

ENGLISH

CONTENTS

INTRODUCTION

Page 3	1.1	General
Page 4	1.2	Product ID codes
Page 4	1.3	Overall dimensions
Page 4	1.4	Identification data

CHAP. 1

INSTALLATION

Page 5	2.1	Important information for the installer
Page 5	2.2	Standard assembly kit
Page 6	2.3	Installing the unit

CHAP. 2

TECHNICAL CHARACTERISTICS

Page 8	3.1	Technical characteristics
--------	-----	---------------------------

CHAP. 3

WARRANTY

Page 9	4.1	Warranty
--------	-----	----------

CHAP. 4

PARAMETER PROGRAMMING

Page 10	5.1	Control panel
Page 10	5.2	Frontal keypad
Page 11	5.3	LED display
Page 12	5.4	General
Page 12	5.5	Key to symbols
Page 12	5.6	Setting and displaying set points
Page 13	5.7	Level 1 programming
Page 13	5.8	List of Level 1 variables
Page 14	5.9	Level 2 programming
Page 14	5.10	List of Level 2 variables
Page 16	5.11	Switching on the ECP200 EXPERT electronic controller
Page 16	5.12	Compressor activation/deactivation conditions
Page 16	5.13	Manual defrosting
Page 17	5.14	Hot gas defrosting
Page 17	5.15	Pump down function
Page 17	5.16	Password protection

CHAP. 5

OPTIONAL

Page 18	6.1	TeleNET monitoring / supervision system
Page 18	6.2	Net configuration with Modbus-rtu protocol
Page 19	6.3	ALARM RELAY / RS485 switching

CHAP. 6

TROUBLESHOOTING

Page 20	7.1	Troubleshooting
---------	-----	-----------------

CHAP. 7

APPENDICES

Page 21	A.1	EC declaration of conformity
Page 22	A.2	ECP200 EXPERT wiring diagram
Page 23	A.3	Part list

CHAPTER 1: INTRODUCTION

GENERAL

1.1

DESCRIPTION:

The **ECP200 EXPERT** is a new control panel for cold rooms with a single-phase compressor up to 2 HP, specially designed to provide the user with safety, protection, control and ease of installation.

It allows the user to control all the components on a refrigerating system: compressor, evaporator fans, defrosting elements, room light and thermostat-holder demisting element.

APPLICATIONS:

- Complete management of single-phase static or ventilated refrigeration systems up to 2 HP, with off-cycle or electrical defrosting and with direct or pump-down compressor stop.
- Control of single-phase evaporator unit only with freon solenoid enable signal or remote condensing unit enable signal.

MAIN CHARACTERISTICS:

- Cold room temperature displaying and regulation with decimal point
- Evaporator temperature displaying from parameter
- Plant control activation/deactivation
- Plant alarms signaling (probe error, minimum and maximum temperature alarm, compressor protection)
- LED indicators and large display illustrate system status.
- User-friendly keypad.
- Evaporator fans management
- Manual and automatic defrost (static, through heaters, through cycle reversal)
- Direct or pump-down management and control of condensing unit up to 2HP
- Cold room light activation through key on the panel or through door-switch
- Direct control of compressor, defrosting elements, evaporator fans, room light with outputs directly connectable to the various units.
- Magneto-thermal cut-out switch for isolation and protection of the refrigeration unit.
- Innovative, smartly designed ABS cover with transparent cover for access to the magneto-thermal cut-out switch, all with an IP65 protection rating so that panel can be used outside the room.
- Auxiliary relay with parameter-configured
- Possibility, as an alternative to an auxiliary relay, of a RS485 port for connection to the TeleNET supervision net or to a net with MODBUS-RTU protocol.

1.2

PRODUCT ID CODES

ECP200 EXPERT

Controls and manages compressor, defrosting elements, evaporator fans and room light.
Aux/Alarms relay
Differential magnetothermic circuit breaker 16A
Id=300 mA (Id=30 mA on request)

1.3

OVERALL DIMENSIONS

Dimensions (mm.)



1.4

IDENTIFICATION DATA

The unit described in this manual has an ID plate on the side showing all the relevant identification data:

- Name of Manufacturer
- Code and model of unit electrical board
- Serial number
- Power supply
- Rated current
- IP protection rating

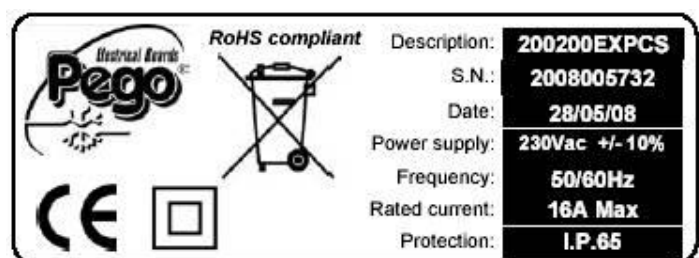

CHAPTER 2: INSTALLATION

IMPORTANT INFORMATION FOR THE INSTALLER

2.1

1. Install the device in places where the protection rating is observed and try not to damage the box when drilling holes for wire/pipe seats.
2. Do not use multi-polar cables in which there are wires connected to inductive/power loads or signalling wires (e.g. probes/sensors and digital inputs).
3. Do not fit power supply wiring and signal wiring (probes/sensors and digital inputs) in the same raceways or ducts.
4. Minimise the length of connector wires so that wiring does not twist into a spiral shape as this could have negative effects on the electronics.
5. All wiring must be of a cross-section suitable for relevant power levels.
6. When it is necessary to make a probe/sensor extension, the wires must have a cross-section of at least 1 mm². Probes extension or shortening could alter their factory calibration; therefore to check and calibrate the probes through an external thermometer.

STANDARD ASSEMBLY KIT

2.2

For the purposes of assembly and use, the electronic **ECP200 EXPERT** control unit comes with:

- N° 3 seals, to be fitted between the fixing screws and the box back panel
- N° 1 user's manual.

2.3

INSTALLING THE UNIT

Fig. 1: Raise the transparent cover that shields the magneto-thermal cut-out switch and remove the screw cover on the right-hand side.



Fig. 2: Undo the 4 fixing screws at the front of the box.



Fig. 3: To close the magnetothermic circuit breaker transparent protection.



Fig. 4: Open the front of the box, lift it and slide the two hinges out as far as they will go.



Fig. 5: Press on the sides of the hinges to remove them from their seats and so remove the front panel completely.

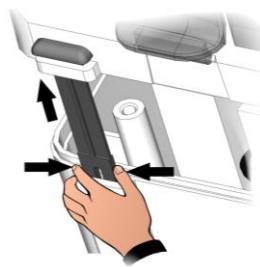

Fig. 6: Use the three existing holes to fix the box back panel to the wall: use three screws of a length suitable for the thickness of the wall to which the panel will be attached. Fit a rubber washer (supplied) between each screw and the box backing.

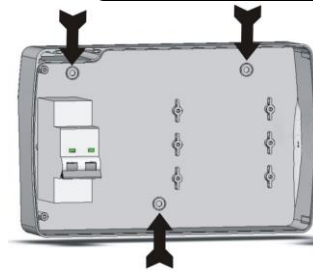
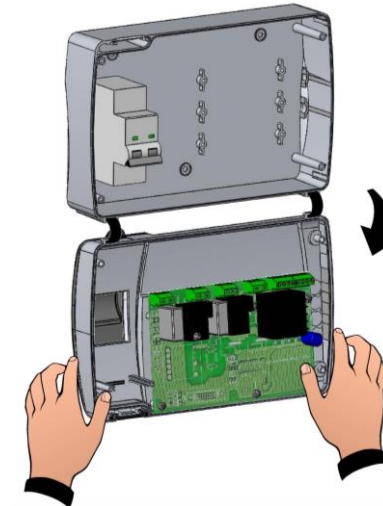

Fig. 7: Hook the frontal panel back up to the lower part of the box by inserting the two hinges in their seats and, bending them, rotate downwards 180° to gain access to the electronic board.



Make all the electrical connections as illustrated in the diagram for the corresponding model (see relative table in APPENDICES).

To effect correct electrical connection and maintain the protection rating, use appropriate wire/raceway grips to ensure a good seal.

Route the wiring inside the unit in as tidy a fashion as possible: be especially careful to keep power wires away from signal wires. Use clips to hold wires in place.



Fig. 8: close the front panel, making sure that all the wires are inside the box and that the box seal sits in its seat properly.

Tighten the front panel using the 4 screws, making sure the O-rings on the head of each screw are used.

Power up the panel and carry out thorough reading/programming of all the parameters.



Be careful not to over-tighten the closure screws as this could warp the box and compromise proper operation of the membrane-type keypad.

Install short-circuit overload safety devices on all the power cables connected to the ECP200 EXPERT so as to prevent damage to the device. Work and/or maintenance must ONLY be carried out on the unit after disconnecting the panel from the power supply and from any inductive/power loads: doing so allows the worker to do his job safely.



CHAPTER 3: TECHNICAL CHARACTERISTICS

3.1

TECHNICAL CHARACTERISTICS

Power supply			
Voltage		230 V~ ± 10% 50Hz / 60Hz	
Max power (only electronics)		~ 7 VA	
Rated current (With all loads connected)		16A	
Cold room conditions			
Working temperature		-5 ÷ +50°C	
Storage temperature		-10 ÷ +70°C	
Relative humidity		Less than 90%	
General characteristics			
Type of sensors that can be connected		NTC 10K 1%	
Resolution		0,1 °C.	
Sensor read precision		± 0,5 °C	
Read range		-45 ÷ +45 °C	
Output characteristics			
Description	Installed relay	Card output characteristics	Note
Compressor	(Relay 30A AC1)	10A 250V~ (AC3) (2HP) (100000 cycles)	The sum of contemporary absorptions of these outputs has not to exceed 16A
Elements	(Relay 30A AC1)	16A 250V~ (AC1)	
Fans	(Relay 16A AC1)	2,7A 250V~ (AC3)	
Room light	(Relay 16A AC1)	16A 250V~ (AC1)	
Alarm / Aux (non-powered contact)	(Relay 8A AC1)	8(3)A 250V~	
General electrical protection		Differential magnetothermic circuit breaker 16A Id=300 mA (Id=30 mA on request) Disconnecting power 4.5 kA	
Dimensional characteristics			
Dimensions		16.8cm x 9.7cm x 26.2cm (HxPxL)	
Insulation / mechanical characteristics			
Box protection rating		IP65	
Box material		self-extinguishing ABS	
Type of insulation		Class II	

WARRANTY

4.1

ECP200 EXPERT series products are covered by a 24-month warranty against all manufacturing defects as from the date indicated on the product ID code or from the date of product registration card, if present.

In the event of a defect the product must be appropriately packaged and sent to our factory or any authorized Service Center by authority RMA number received.

Customers are entitled to have defective products repaired, spare parts and labour included. Transport expenses and risk shall be met entirely by the customer.

Repairs carried out under warranty do not prolong or renew the warranty expiration date.

The Warranty does not cover:

- Damages resulting from tampering, impact or improper installation of humidifier and its accessories.
- Behaviour inconsistent with Manufacturer's prescriptions and instructions.
- Damages caused by repairs made by unauthorized persons.
- Spare parts (immersed electrodes steam cylinder)
- Damages caused by natural phenomena as lightning, natural calamities, etc.

Warranty cover may be refused if the device is modified or changed.

Under no circumstances **Pego S.r.l.** will be responsible for possible loss of data and information, costs of substitutive goods or services, damages to things, people or animals, non-sale or non-gain, activity interruption, possible direct, indirect, accidental, property, covering, punitive, special or consequential damages anyhow caused, whether they are contractual, extra-contractual or due to negligence or other responsibility, derived from product use or from its installation.

The wrong machine working caused by manumissions, shoves, inadequate installation automatically forfeits the warranty right. It is compulsory to respect all information of this user manual and device operating conditions.

PEGO S.r.l. declines any responsibility for possible errors or inaccuracies written in this manual as a result of printing or transcription errors.

PEGO S.r.l. reserves the right to modify its products as it deems necessary without altering its main characteristics. Each new release of a PEGO user manual replaces all the previous ones.

However not expressly indicated, the warranty follows the laws in force and particularly the section 1512 C.C. (Italian Civil Code)

For any controversy is elected by the parties and recognized the jurisdiction of the Court of Rovigo.

CHAPTER 5: PARAMETER PROGRAMMING



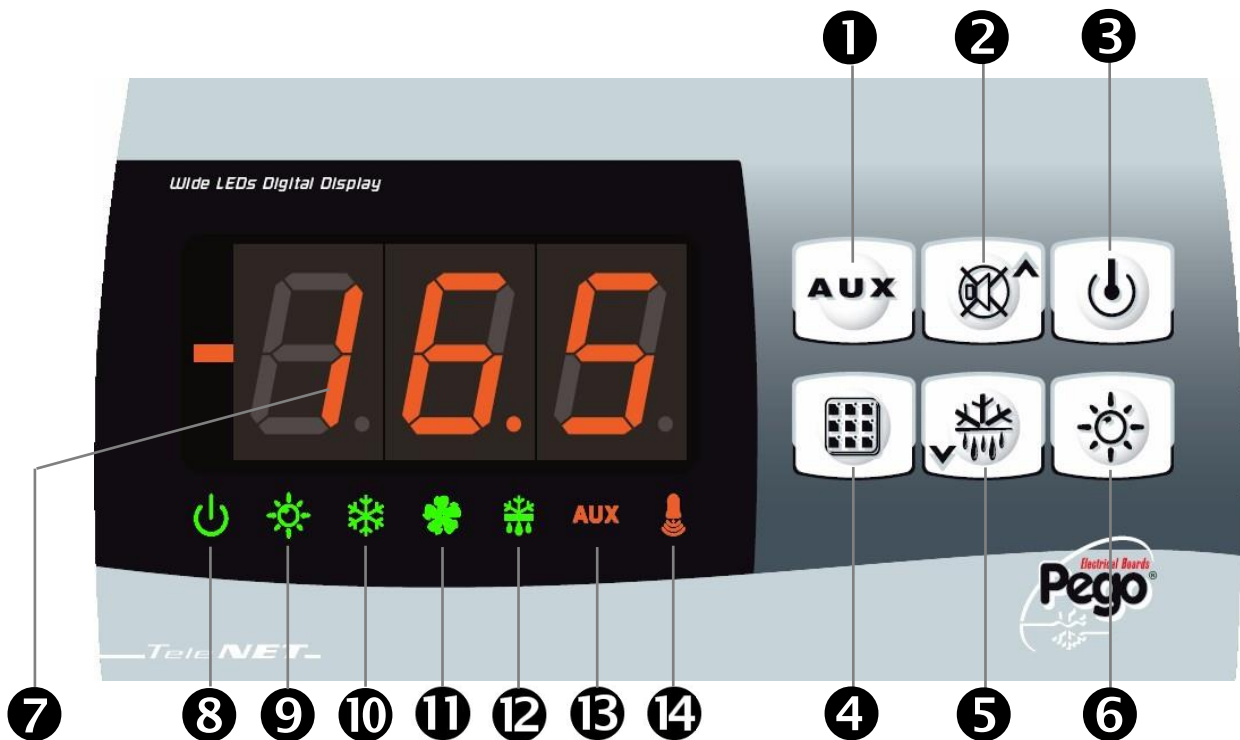

5.1

CONTROL PANEL



5.2

FRONT KEYPAD

- 1

AUXILIARY RELAY CONTROL (on the version with alarm relay controls the relay manual if parameter AU=1)
- 2

UP / MUTE BUZZER ALARM
- 3

STAND BY (if the system shuts down the LED flashes)
- 4

room temperature SETTING

5  DOWN / MANUAL DEFROST

6  ROOM LIGHT

LED DISPLAY

5.3

7 Cold room temperature / parameters

8  Stand-by (flashes on stand-by. Outputs are deactivated)

9  Room light (flashes if door switch activated)

10  Cold (indicates activation of compressor)

11  Fans

12  Defrosting

13 **AUX** Auxiliary

14  Alarm/warning

5.4

GENERAL



To enhance safety and simplify the operator's work, the **ECP200 EXPERT** has two programming levels; the first level (Level 1) is used to configure the frequently-modified **SETPOINT** parameters. The second programming level (Level 2) is for general parameter programming of the various controller work modes.

It is not possible to access the Level 2 programming directly from Level 1: you must exit the programming mode first.

5.5

KEY TO SYMBOLS

For purposes of practicality the following symbols are used:

- (▲) the UP key  is used to increase values and mute the alarm.
- (▼) the DOWN key  is used to decrease values and force defrosting.

5.6

SETTING AND DISPLAYING THE SET POINTS

1. Press the **SET key** to display the current **SETPOINT** (temperature)
2. Hold down the **SET key** and press the (▲) or (▼) keys to modify the **SETPOINT**.

Release the **SET key** to return to cold room temperature display: the new setting will be saved automatically.

LEVEL 1 PROGRAMMING (User level)

5.7

To gain access to the Level 1 configuration menu proceed as follows:

1. Press the (▲) and (▼) keys simultaneously and keep them pressed for a few seconds until the first programming variable appears on the display.
2. Release the (▲) and (▼) keys.
3. Select the variable to be modified using the (▲) or (▼) key.
4. When the variable has been selected it is possible:
 - to display the setting by pressing SET key
 - to modify the setting by pressing the SET key together with the (▲) or (▼) key.

When configuration values have been set you can exit the menu by pressing the (▲) and (▼) keys simultaneously for a few seconds until the cold room temperature reappears.

5. The new settings are saved automatically when you exit the configuration menu.

LIST OF LEVEL 1 VARIABLES (User level)

5.8

VARIABLES	MEANING	VALUE	DEFAULT
<i>r0</i>	Temperature difference compared to main SETPOINT	0.2 - 10 °C	2°C
<i>d0</i>	Defrost interval (hours)	0 - 24 hours	4 hours
<i>d2</i>	End-of-defrost setpoint. Defrost is not executed if the temperature read by the defrost sensor is greater than <i>d2</i> (If the sensor is faulty defrosting is timed)	-35 - 45 °C	15°C
<i>d3</i>	Max defrost duration (minutes)	1 - 240 min	25 min
<i>d7</i>	Drip duration (minutes) At the end of defrost the compressor and fans remain at standstill for time <i>d7</i> , the defrost LED on the front panel flashes.	0 - 10 min	0 min
<i>F5</i>	Fan pause after defrost (minutes) Allows fans to be kept at standstill for a time <i>F5</i> after dripping. This time begins at the end of dripping. If no dripping has been set the fan pause starts directly at the end of defrost.	0 - 10 min	0 min
<i>A1</i>	Minimum temperature alarm Allows user to define a minimum temperature for the room being refrigerated. Below value <i>A1</i> an alarm trips: the alarm LED flashes, displayed temperature flashes and the buzzer sounds to indicate the problem.	-	-45°C
<i>A2</i>	Maximum temperature alarm Allows user to define a maximum temperature for the room being refrigerated. Above value <i>A2</i> an alarm trips: the alarm LED flashes, displayed temperature flashes and the buzzer sounds to indicate the problem.	-	+45°C
<i>tEu</i>	Evaporator sensor temperature display (displays nothing if <i>dE</i> =1)	temperature	read only

5.9

LEVEL 2 PROGRAMMING (Installer level)

To access the second programming level press the UP (▲) and DOWN (▼) keys and the LIGHT key simultaneously for a few seconds.

When the first programming variable appears the system automatically goes to stand-by.

1. Select the variable to be modified by pressing the UP (▲) and DOWN (▼) keys.

When the parameter has been selected it is possible to:

2. View the setting by pressing the SET key.

3. Modify the setting by holding the SET key down and pressing the (▲) or (▼) key.

4. When configuration settings have been completed you can exit the menu by pressing the (▲) and (▼) keys simultaneously and keeping them pressed until the room temperature reappears.

5. Changes are saved automatically when you exit the configuration menu.

6. Press the STAND-BY key to enable electronic control.

5.10

LIST OF LEVEL 2 VARIABLES (Installer level)

VARIABLES	MEANING	VALUES	DEFAULT
AC	Door switch status (with door closed)	0 = normally open 1 = normally closed	0
F3	Fan status with compressor off	0 = Fans run continuously 1 = Fans only run when compressor is working	1
F4	Fan pause during defrost	0 = Fans run during defrost 1 = Fans do not run during defrost	1
dE	Sensor presence If the evaporator sensor is disabled defrosts are carried out cyclically with period d0: defrosting ends when an external device trips and closes the remote defrost contact or when time d3 expires.	0 = evaporator sensor present 1 = no evaporator sensor	0
d1	Defrost type , cycle inversion (hot gas) or with heater elements	1 = hot gas 0 = element	0
Ad	Net address for connection to TeleNET supervision system or Modbus	0 ÷ 31 (with AU=3) 1 ÷ 247 (with AU=7)	0
Ald	Minimum and maximum temperature signalling and alarm display delay	1...240 min	120 min
C1	Minimum time between shutdown and subsequent switching on of the compressor.	0...15 min	0 min
CAL	Cold room sensor value correction	-10...+10	0
Pc	Compressor protection contact status	0 = NO 1 = NC	0 = NO

doC	Compressor safety time for door switch: when the door is opened the evaporator fans shut down and the compressor will continue working for time doC , after which it will shut down.	0...5 minutes	0
tdo	Compressor restart time after door opening. when the door is opened and after tdo time, it's setted back the normal functioning giving door open alarm (Ed) With tdo=0 the parameter is disabled.	0...240 min 0 = disabled	0
Fst	FAN shutdown TEMPERATURE The fans will stop if the temperature value read by the evaporator sensor is higher than this value.	-45...+45°C	+45°C
Fd	Fst differential	0...+10°C	2°C
LSE	Minimum value attributable to setpoint.	-45... HSE °C	-45°C
HSE	Maximum value attributable to setpoint.	+45... LSE °C	+45°C
tA	NO – NC alarm relay switching	0 = activates when alarm is on 1 = deactivates when alarm is on	1
AU	Auxiliary/alarm relay control	0 = alarm relay 1 = manual auxiliary relay controlled via AUX key 2 = automatic auxiliary relay managed by StA temp. setting with 2°C differential 3 = relay disabled / TeleNET function 4 = pump down function (see CHAP 5.15) 5 = free voltage contact for condensing unit (AUX relay and compressor relay in parallel) 6 = Contact for casing element control (AUX relay closed with compressor output inactive). 7 = relay disabled / Modbus-RTU function	0
StA	Temp. setting for aux. relay	-45...+45°C	0
In1	Man in cold room alarm Select input INP1 on the board as <i>compressor protection alarm</i> or as <i>man in cold room alarm</i> (contact NC).	0 = compressor protection 1 = man in room alarm	0
P1	Password type of protection (active when PA is not equal 0)	0 = only display set point 1 = display set point, AUX, light access 2 = access in programming not permitted 3 = access in second level programming not permitted	3
PA	Password (see P1 for the type of protection)	0...999 0 = not active	0
reL	Software release	indicates software version	7 (Read only)

5.11

SWITCHING ON THE ECP200 EXPERT ELECTRONIC CONTROLLER

After wiring the electronic controller correctly, power up at 230 V AC; the display panel will immediately emit a beep and all the LEDs will come on simultaneously for a few seconds.

5.12

COMPRESSOR ACTIVATION/DEACTIVATION CONDITIONS

The **ECP200 EXPERT** controller activates the compressor when cold room temperature exceeds setting+differential (r0); it deactivates the compressor when cold room temperature is lower than the setting.

5.13

MANUAL DEFROSTING

To defrost just press the dedicated key (see section 5.2) to activate the elements relay. Defrosting will not take place if the end-of-defrost temperature setting (d2) is lower than the temperature detected by the evaporator sensor. Defrosting ends when the end-of-defrost temperature (d2) or maximum defrost time (d3) is reached.

HOT GAS DEFROSTING**5.14**

Set parameter d1 =1 to defrost in cycle inversion mode.

The compressor relay and defrost relay are activated throughout the defrost phase.

To ensure proper control of the system the installer must use the defrost output: this must allow opening of the cycle inversion solenoid valve and closure of the liquid solenoid valve.

For capillary systems (without thermostat valve) it is only necessary to control the cycle inversion solenoid valve via the defrost relay control.

PUMP DOWN FUNCTION**5.15**

Pump down function is activated when parameter AU=4.

Connect pump down pressostat on the digital input INP-1. The compressor is directly controlled by pressostat.

Connect evaporator solenoid valve on the AUX relay. The solenoid is controlled directly by thermostat.

PASSWORD FUNCTION**5.16**

When parameter PA is setting with value different to 0 the protection function is activated.

See parameter P1 for the different protection.

When PA is setting the protection start after two minutes of inactivity. On display appear 000. With up/down modify the number, with set key confirm it.

Use universal number 100 if you don't remember the password.

CHAPTER 6: OPTIONAL KITS

6.1

TELENET MONITORING AND SUPERVISION SYSTEM

For **TeleNET** connections to enable RS485 as indicated at chapter 6.3 and follow the scheme below. Refer to **TeleNET** user manual for instrument configuration.

WARNING: During configuration, at entry "Module" to select the entry "Instrument ECP Base Series / ECP Expert Series".

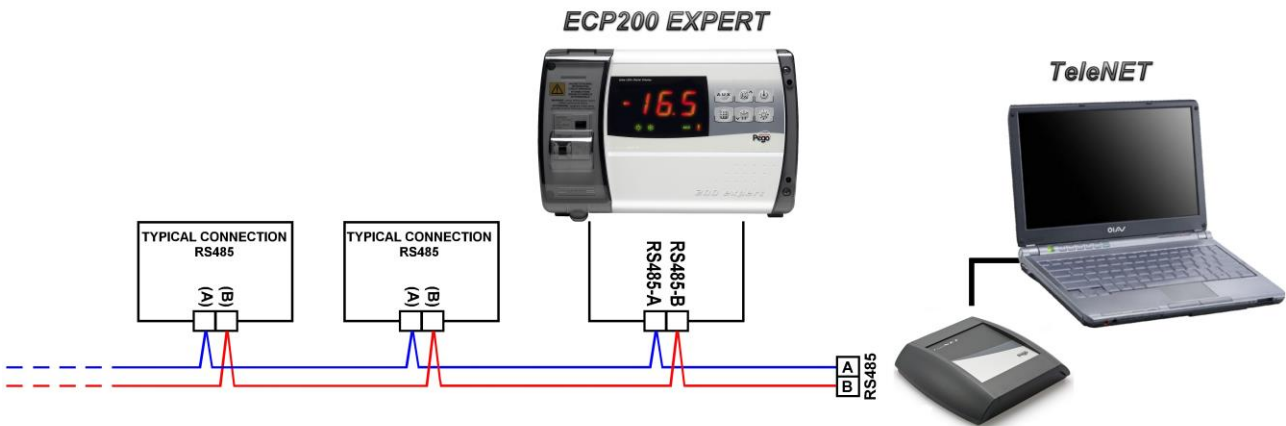

6.2

NET CONFIGURATION WITH MODBUS-RTU PROTOCOL

For **RS485** connections with **Modbus-RTU** protocol, to enable RS485 output as indicated at chapter 6.3 and follow the scheme below.

Refer to MODBUS-RTU_ECP200T1 user manual (available on Pego Internet web site) for MODBUS-RTU communication protocol specification.

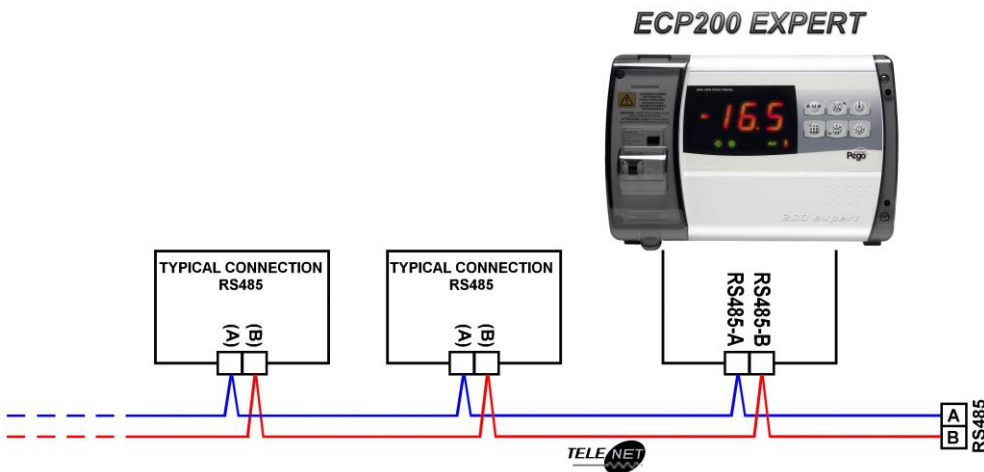

ALARM RELAY / RS485 SWITCHING

6.3

Open the front of the box as described in Chap. 2.3 (page 6): rotate it downwards 180° to gain access to the electronic board.

Undo the 6 CPU board fixing screws: remove the board from the frontal part of the box in ABS.

Configure the jumper from JUMPER JP2 (placed on the front of electrical board near the display far down on the right) following one of the ensuing options.

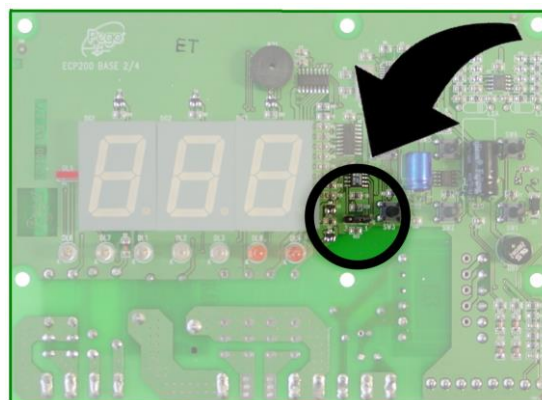
**RS485 output selection:**

Insert the jumper JP2 on 3-2 position and set the 2nd level variable

AU=3 (TeleNET)

or

AU=7 (Modbus-RTU).

The connection clamps are RS485 (A) and RS485_(B) on board of electrical board. Remember besides to assign an univocal net address in the current instruments net. (Ad 2nd level parameter).

Warning! with this configuration auxiliary relay is disabled.

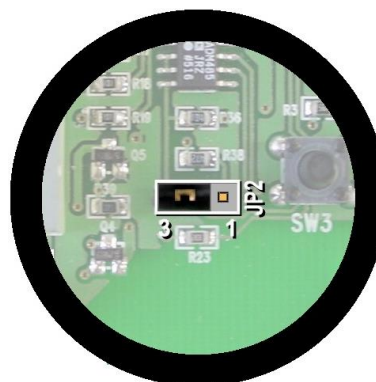
**AUX/Alarm relay selection:**

Insert the jumper JP2 in 2-1 position and set the 2nd level variable AU to a value different from 3 and 7 according to the needed function. Clamps of configurable relay clean contact are on AUX/ALL output, on board of electronic board.

Warning! With this configuration RS485 connection is disabled.

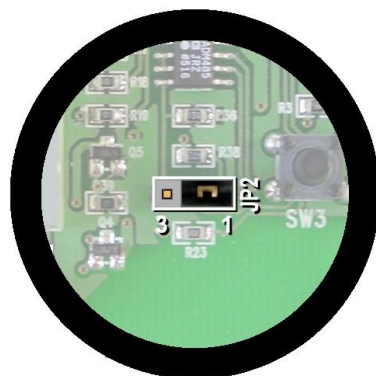

CHAPTER 7: TROUBLESHOOTING

7.1

TROUBLESHOOTING

In the event of any anomalies the ECP200 EXPERT warns the operator by displaying alarm codes and sounding the warning buzzer inside the control panel. If an alarm is tripped the display will show one of the following messages.

ALARM CODE	POSSIBLE CAUSE	SOLUTION
E0	<i>Cold room temperature sensor not working properly</i>	<ul style="list-style-type: none"> • Check that cold room temperature sensor is working properly • If the problem persists replace the sensor
E1	<i>Defrost sensor not working properly</i> (In this case defrosts will last time d3)	<ul style="list-style-type: none"> • Check that defrost sensor is working properly • If the problems persists replace the sensor
E2	<i>Eeprom alarm</i> An EEPROM memory alarm has been detected (All outputs except the alarm one are deactivated)	<ul style="list-style-type: none"> • Switch unit off and back on
E8	<i>Man in cold room alarm</i>	<ul style="list-style-type: none"> • Reset the alarm input inside the cold room
Ec	<i>Compressor protection tripped</i> (e.g. thermal protection or max pressure switch) (All outputs except the alarm one – where applicable – are deactivated)	<ul style="list-style-type: none"> • Check that compressor is working properly • Check compressor absorption • If the problem persists contact the technical assistance service
Ed	<i>Open door Alarm.</i> When the door is opened and after tdo time, it's setted back the normal functioning giving door open alarm (Ed)	<ul style="list-style-type: none"> • Check door switch status • Check door switch connections • If the problem persists contact the technical assistance service
Temperature shown on display is flashing	<i>Minimum or maximum temperature alarm.</i> The temperature inside the cold room has exceeded the min. or max. temperature alarm setting (see variables A1 and A2, user programming level)	<ul style="list-style-type: none"> • Check that the compressor is working properly. • Sensor not reading temperature properly or compressor start/stop control not working.

APPENDICES**EC declaration of conformity****A.1****COSTRUTTORE / MANUFACTURER:**

PEGO S.r.l. Via Piacentina, 6/b 45030 Occhiobello (RO) – Italy –
Tel. (+39) 0425 762906 Fax. (+39) 0425 762905

DENOMINAZIONE DEL PRODOTTO / NAME OF THE PRODUCT:

MOD.: ECP200 EXPERT

IL PRODOTTO E' CONFORME ALLE SEGUENTI DIRETTIVE CE:**THE PRODUCT IS IN CONFORMITY WITH THE REQUIREMENTS OF THE FOLLOWING EUROPEAN DIRECTIVES:**

Direttiva Bassa Tensione (LVD): **2014/35/UE**
Low voltage directive (LVD): **2014/35/EU**

Direttiva EMC: **2014/30/CE**
Electromagnetic compatibility (EMC): **2014/30/EU**

LA CONFORMITA' PRESCRITTA DALLA DIRETTIVA E' GARANTITA DALL'ADEMPIMENTO A TUTTI GLI EFFETTI DELLE SEGUENTI NORME (comprese tutte le modifiche):

THE CONFORMITY WITH THE REQUIREMENTS OF THIS DIRECTIVE IS TESTIFIED BY COMPLETE ADHERENCE TO THE FOLLOWING STANDARDS (including all amendments):

Norme armonizzate: **EN 60204-1:2006, EN 61439-1:2011, EN 61000-6-1:2007, EN 61000-6-3:2007**
European standards: EN 60204-1:2006, EN 61439-1:2011, EN 61000-6-1:2007, EN 61000-6-3:2007

IL PRODOTTO E' COSTITUITO PER ESSERE INCORPORATO IN UNA MACCHINA O PER ESSERE ASSEMBLATO CON ALTRI MACCHINARI PER COSTITUIRE UNA MACCHINA CONSIDERATE DALLA DIRETTIVA: 2006/42/CE "Direttiva Macchine".

THE PRODUCT HAS BEEN MANUFACTURED TO BE INCLUDED IN A MACHINE OR TO BE ASSEMBLED TOGETHER WITH OTHER MACHINERY TO COMPLETE A MACHINE ACCORDING TO DIRECTIVE: EC/2006/42 "Machinery Directive".

Occhiobello (RO), 01/04/2016

Paolo Pegorari
Rappresentante Legale

A.2

ECP200 EXPERT WIRING DIAGRAM

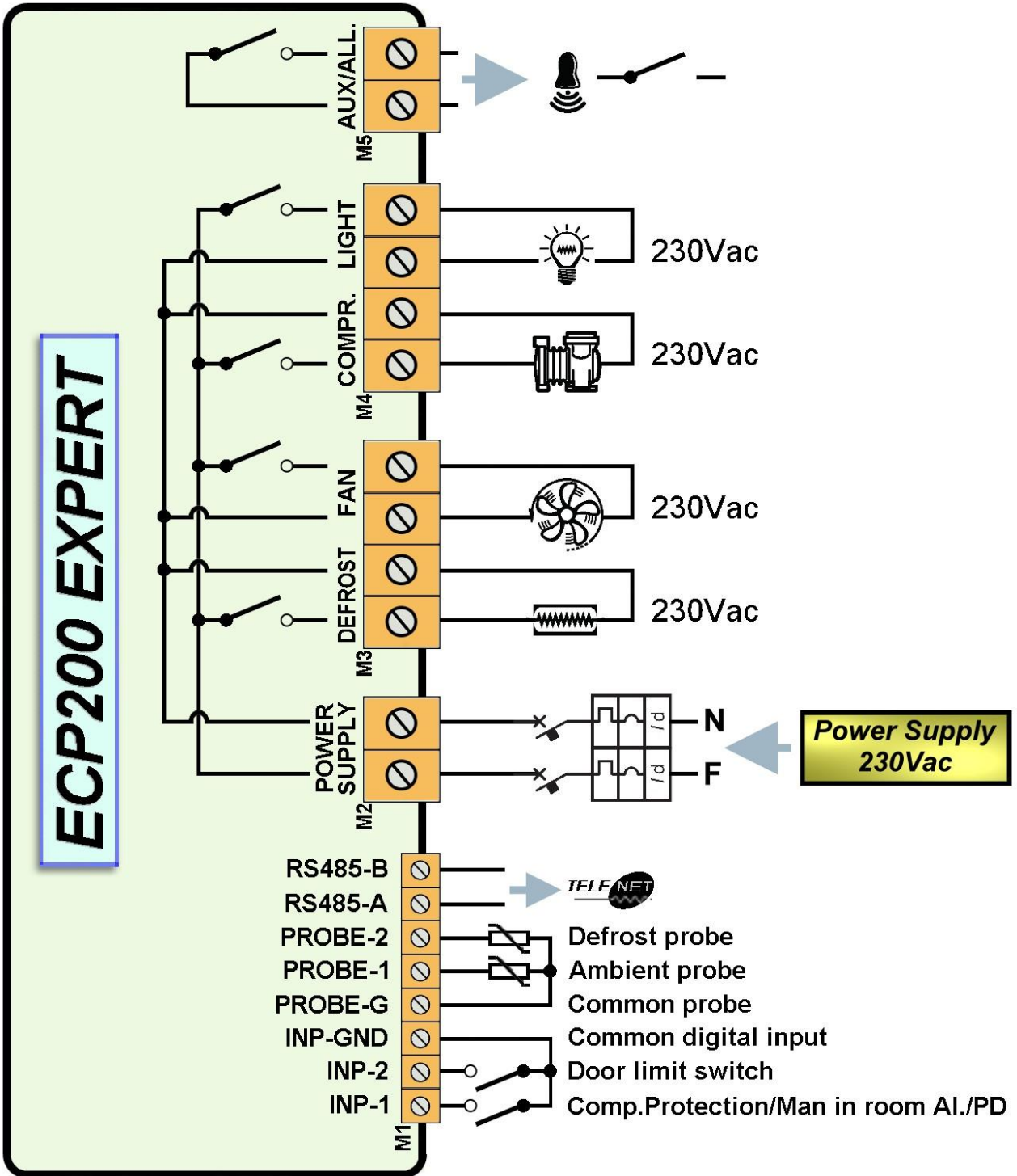

Part list

A.3

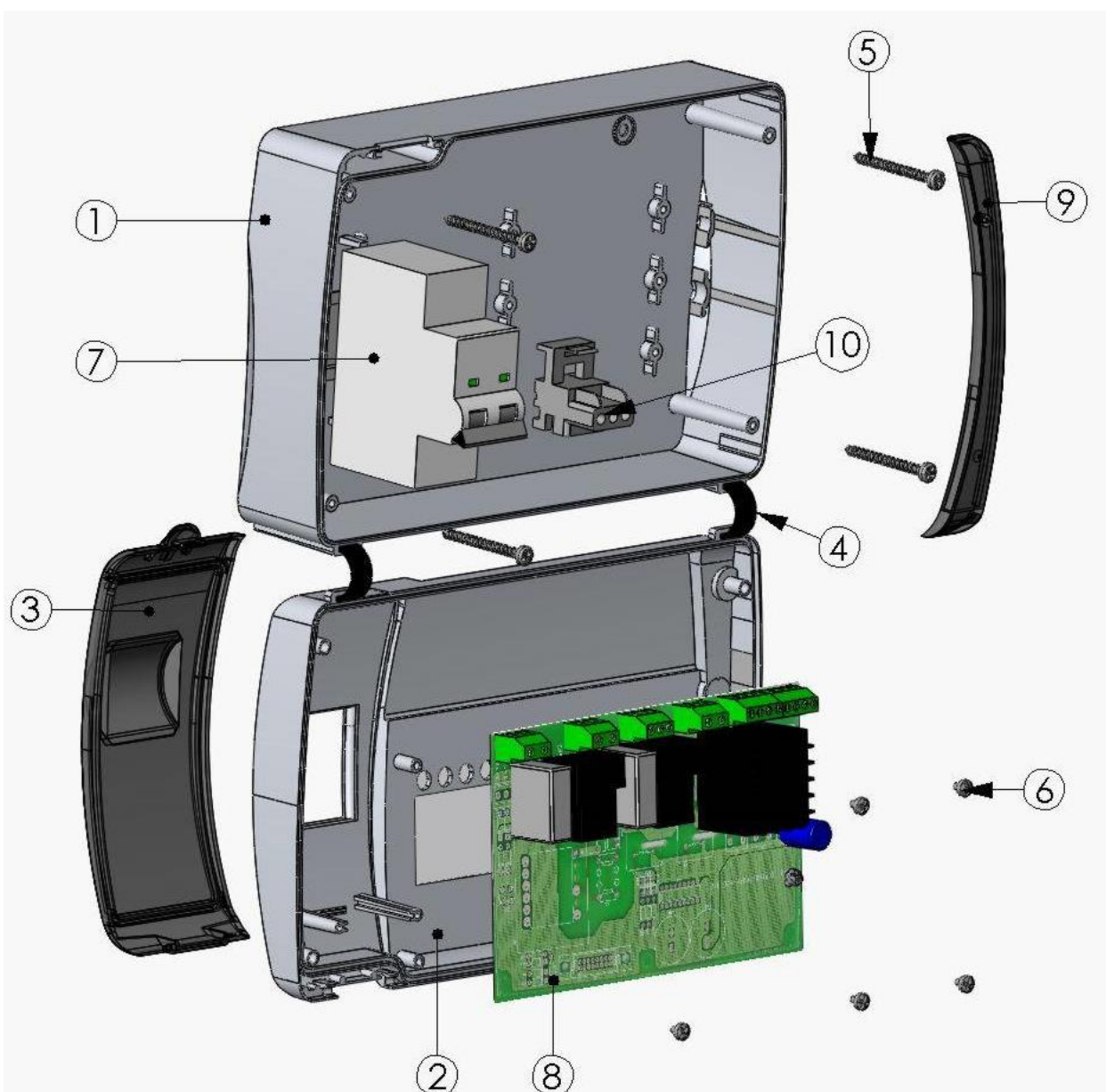

KEY	
REF.	DESCRIPTION
1	BOX REAR IN ABS
2	BOX FRONT IN ABS
3	FRONT COVER IN TRANSPARENT POLYCARBONATE
4	BOX FRONT OPENING HINGE
5	BOX CLOSURE SCREWS
6	BOARD FIXING SCREWS
7	MAGNETO-THERMAL CUT-OUT / POWER BREAKER
8	CPU BOARD
9	POLYCARBONATE SCREW COVER
10	TERMINAL FOR EARTH CONNECTIONS



PEGO S.r.l.

Via Piacentina, 6/b

45030 OCCHIOBELLO –ROVIGO-

Tel : 0425 762906

Fax: 0425 762905

www.pego.it

e-mail: info@pego.it

Distributor: