

ECP200 EXPERT PULSE

ECP 200 EXPERT PULSE PER EEV PULSE 230V



Use and maintenance manual

ENGLISH

READ AND KEEP

CONTENTS

INTRODUCTION

CHAP. 1

Page 3	1.1	General
Page 4	1.2	Product ID codes
Page 4	1.3	Overall dimensions
Page 4	1.4	Identification data

INSTALLATION

CHAP. 2

Page 5	2.1	Important information for the installer
Page 5	2.2	Standard assembly kit
Page 6	2.3	Installing the unit

TECHNICAL CHARACTERISTICS

CHAP. 3

Page 8	3.1	Technical characteristics
--------	-----	---------------------------

WARRANTY

CHAP. 4

Page 9	4.1	Warranty
--------	-----	----------

PARAMETER PROGRAMMING

CHAP. 5

Page 10	5.1	Control panel
Page 10	5.2	Frontal keypad
Page 11	5.3	LED display
Page 12	5.4	Key shortcut
Page 12	5.5	Setting and displaying set points
Page 13	5.6	Level 1 programming
Page 13	5.7	List of Level 1 variables
Page 14	5.8	Level 2 programming
Page 14	5.9	List of Level 2 variables
Page 18	5.10	Level 3 programming
Page 18	5.11	List of Level 3 variables
Page 21	5.12	Loading defaults under variable EEV
Page 22	5.13	Quick menu displaying variables
Page 22	5.14	List of quick menu displaying variables
Page 23	5.15	Mode of operation thermostat
Page 23	5.16	Password protection
Page 23	5.17	Emergency operation in case of error E0
Page 23	5.18	Manual activation of defrost
Page 24	5.19	Force manual defrost end
Page 24	5.20	Hot gas defrosting
Page 24	5.21	Displaying temperature after defrost
Page 24	5.22	Pump down function

OPTIONAL

CAP. 6

Page 25	6.1	<i>TeleNET</i> monitoring / supervision system
Page 25	6.2	Net configuration with Modbus-rtu protocol

TROUBLESHOOTING

CAP. 7

Page 26	7.1	Troubleshooting
---------	-----	-----------------

APPENDICES

Page 28	A.1	EC declaration of conformity
Page 29	A.2	Connection Diagram
Page 30	A.3	Part list

CHAPTER 1: INTRODUCTION

GENERAL

1.1

DESCRIZIONE:

The **ECP200 EXPERT PULSE** is a new control panel for cold rooms with magneto-thermal cut-out switch for the management of the refrigeration system with integrated control of electronic expansion valve ON / OFF with coil to 230 VAC and single-phase compressor up to 2 HP.

It allows the user to control all the components on a refrigerating system: compressor, EEV pulse, evaporator fans, defrosting elements room light and thermostat-holder demisting element.

APPLICATIONS:

- Complete management of single-phase static or ventilated refrigeration systems up to 2 HP, with off-cycle or electrical defrosting and with direct or pump-down compressor stop.
- for plants with evaporator managed by the electronic expansion valve ON/OFF at 230Vac.
- Real time clock defrosting
- Control of single-phase evaporator unit only with electronic expansion valve ON/OFF 230 Vac or remote condensing unit enable signal.

MAIN CHARACTERISTICS:

- Cold room temperature displaying and regulation with decimal point
- Evaporator temperature displaying from parameter
- Plant control activation/deactivation
- Plant alarms signaling (probe error, minimum and maximum temperature alarm, compressor protection)
- LED indicators and large display illustrate system status..
- User-friendly keypad.
- Evaporator fans management
- Manual and automatic defrost (static, through heaters, through cycle reversal)
- Direct or pump-down management and control of condensing unit up to 2HP
- Cold room light activation through key on the panel or through door-switch
- Direct control of compressor, defrosting elements, evaporator fans, room light with outputs directly connectable to the various units.
- Magneto-thermal cut-out switch for isolation and protection of the refrigeration unit.
- Innovative, smartly designed ABS cover with transparent cover for access to the magneto-thermal cut-out switch, all with an IP65 protection rating so that panel can be used outside the room.
- Auxiliary relay with parameter-configured
- Possibility, as an alternative to an auxiliary relay, of a RS485 port for connection to the TeleNET supervision net or to a net with MODBUS-RTU protocol.

1.2

PRODUCT ID CODES

ECP200 EEV

controls and manages compressor, defrosting elements, evaporator fans and room light.

Aux/Alarms relay

Differential magnetothermic circuit breaker 16A
Id=300 mA (Id=30 mA on request)

Chap. 1 - Introduction

1.3

OVERALL DIMENSIONS

Dimensions (mm)



1.4

IDENTIFICATION DATA

The unit described in this manual has an ID plate on the side showing all the relevant identification data

- Name of Manufacturer
- Code and model of unit electrical board
- Serial number
- Power supply
- Rated current
- IP protection rating

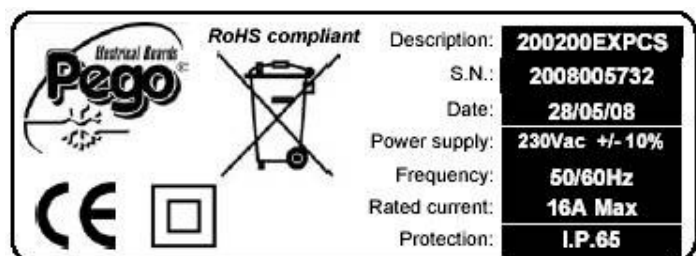

CHAPTER 2: INSTALLATION

GENERAL WARNINGS FOR THE INSTALLER

2.1

1. Install the device in places where the protection rating is observed and try not to damage the box when drilling holes for wire/pipe seats.
2. Do not use multi-polar cables in which there are wires connected to inductive/power loads or signalling wires (e.g. probes/sensors and digital inputs).
3. Do not fit power supply wiring and signal wiring (probes/sensors and digital inputs) in the same raceways or ducts.
4. Minimise the length of connector wires so that wiring does not twist into a spiral shape as this could have negative effects on the electronics.
5. All wiring must be of a cross-section suitable for relevant power levels.
6. When it is necessary to make a probe/sensor extension, the wires must have a cross-section of at least 1 mm². Probes extension or shortening could alter their factory calibration; therefore to check and calibrate the probes through an external thermometer.

STANDARD EQUIPMENT INCLUDED FOR INSTALLATION AND OPERATION

2.2

The electronic controller ECP200 EXPERT PULSE, is equipped with the following for installation and operation:

- 3 sealing gaskets, to place between the fastening screws and the base of the box;
- 1 user manual.

2.3

INSTALLING THE ELECTRICAL PANEL

Fig. 1: Lift the transparent door that protects the differential magnetothermal circuit breaker and remove the cover for the screws on the right side.



Fig. 2: Remove the 4 fastening screws from the front panel of the box.



Fig. 3: Close the transparent door that protects the differential magnetothermal circuit breaker.



Fig.4: Open the front panel of the box by lifting it and sliding the two hinges until they reach the end stop.



Fig. 5: Press on the sides of each hinge to unlodge it and completely remove the front panel.

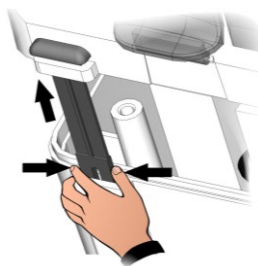

Fig. 6: Use the three pre-existing holes to fasten the base of the box with three adequately long screws based on the thickness of the wall that the panel will be installed on. Place a rubber washer (included) between each fastening screw and the base of the box.

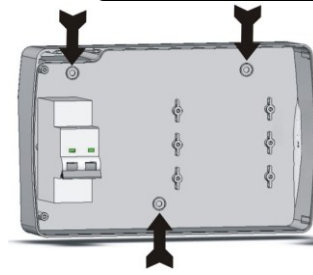
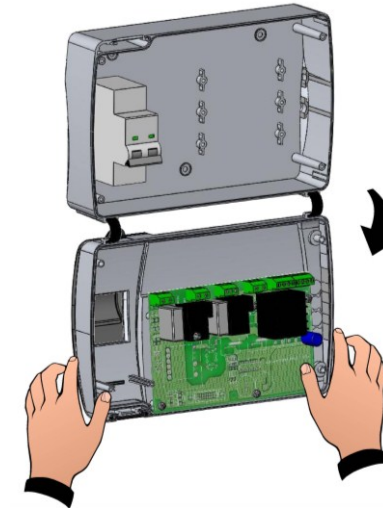

Fig. 7: Hook the front panel back on to the base of the box by re-inserting the hinges into their slots and making them bend. Rotate the panel downwards by 180° to access the PCB.



Make all of the electrical connections according to the attached diagrams for the corresponding model (see the relative tables in ANNEXES). To make the electrical connections in a secure manner and maintain the degree of IP protection of the box it is advisable to use suitable cable and/or conduit glands to seal all of the cables. It is advisable to distribute the arrangement of the conductors inside the panel in the most orderly manner possible, and especially keep the power conductors away from the signal ones. Use sealing straps if necessary



Fig. 8: Close the front panel again, paying attention that the cables are inside the box and that the gasket for the box is correctly lodged into place. Fasten the front panel with the 4 screw, and by re-using the O-rings included on the throat of each screw. Power the panel and perform a thorough reading/programming of all of the set parameters.



Be sure not to tighten the closing screws excessively as this could cause the box to become deformed and jeopardise its correct functioning and tactile effect of the keyboard on the panel. Install protection devices against power surges for short-circuits, in order to avoid damage to the device on all of the loads connected to the electronic controller ECP200. Every time repair and/or maintenance is performed the panel must be disconnected from the power supply and from all possible inductive and power loads that it may be connected to; this is to guarantee the maximum safety conditions for the operator.



CHAPTER 3: TECHNICAL FEATURES

3.1

TECHNICAL FEATURES

Power supply			
Voltage	230 V~ ± 10% 50Hz / 60Hz		
Max. absorbed power (only electronic control)	~ 7 VA		
Maximum absorption allowed (With all loads connected)	16A		
Climatic Conditions			
Working temperature	-5 ÷ +50°C		
Storage temperature	-10 ÷ +70°C		
Ambient relative humidity	Below 90% Hr		
General Features			
Type of temperature probes that can be connected	temperature probes: NTC 10K 1%		
Resolution	0.1 °C.		
Precision of the probe readings	± 0,5 °C		
Range of reading	-45 ÷ +45 °C		
Type of pressure probe that can be connected:	pressure probe: 4/20mA / radiometric 0-5V		
Output features			
Description	Relay installed	Features outputs board	Notes
Compressor	(Relay 30A AC1)	10A 250V~ (AC3) (2HP) (100000 cycles)	The sum of contemporary absorptions of the following loads must not exceed 16A
Resistances	(Relay 30A AC1)	16A 250V~ (AC1)	
Fans	(Relay 16A AC1)	2,7A 250V~ (AC3)	
Cold room light	(Relay 16A AC1)	16A 250V~ (AC1)	
Alarm/Aux (voltage-free contact)	(Relay 8A AC1)	8(3)A 250V~	
Pulse valve	triac	50VA Pulse valve	
General electric protection		Bipolar magnetothermal differential circuit breaker 16A Id=300mA (Id=30mA upon request) Power of interruption 4.5 kA	
Features of the measurements			
Measurements	16.8cm x 9.7cm x 26.2cm (HxLxW)		
Insulation and mechanical features			
Degree of IP protection for the box	IP65		
Box material	ABS self-extinguishing		
Type of insulation	Class II		

WARRANTY

4.1

ECP200 EXPERT series products are covered by a 24-month warranty against all manufacturing defects as from the date indicated on the product ID code or from the date of product registration card, if present.

In the event of a defect the product must be appropriately packaged and sent to our factory or any authorized Service Center by authority RMA number received.

Customers are entitled to have defective products repaired, spare parts and labour included. Transport expenses and risk shall be met entirely by the customer.

Repairs carried out under warranty do not prolong or renew the warranty expiration date.

The Warranty does not cover:

- Damages resulting from tampering, impact or improper installation of humidifier and its accessories.
- Behaviour inconsistent with Manufacturer's prescriptions and instructions.
- Damages caused by repairs made by unauthorized persons.
- Spare parts (immersed electrodes steam cylinder)
- Damages caused by natural phenomena as lightning, natural calamities, etc.

Warranty cover may be refused if the device is modified or changed.

Under no circumstances **Pego S.r.l.** will be responsible for possible loss of data and information, costs of substitutive goods or services, damages to things, people or animals, non-sale or non-gain, activity interruption, possible direct, indirect, accidental, property, covering, punitive, special or consequential damages anyhow caused, whether they are contractual, extra-contractual or due to negligence or other responsibility, derived from product use or from its installation.

The wrong machine working caused by manumissions, shoves, inadequate installation automatically forfeits the warranty right. It is compulsory to respect all information of this user manual and device operating conditions.

PEGO S.r.l. declines any responsibility for possible errors or inaccuracies written in this manual as a result of printing or transcription errors.

PEGO S.r.l. reserves the right to modify its products as it deems necessary without altering its main characteristics. Each new release of a PEGO user manual replaces all the previous ones.

However not expressly indicated, the warranty follows the laws in force and particularly the section 1512 C.C. (Italian Civil Code)

For any controversy is elected by the parties and recognized the jurisdiction of the Court of Rovigo.

CHAPTER 5: PARAMETER PROGRAMMING



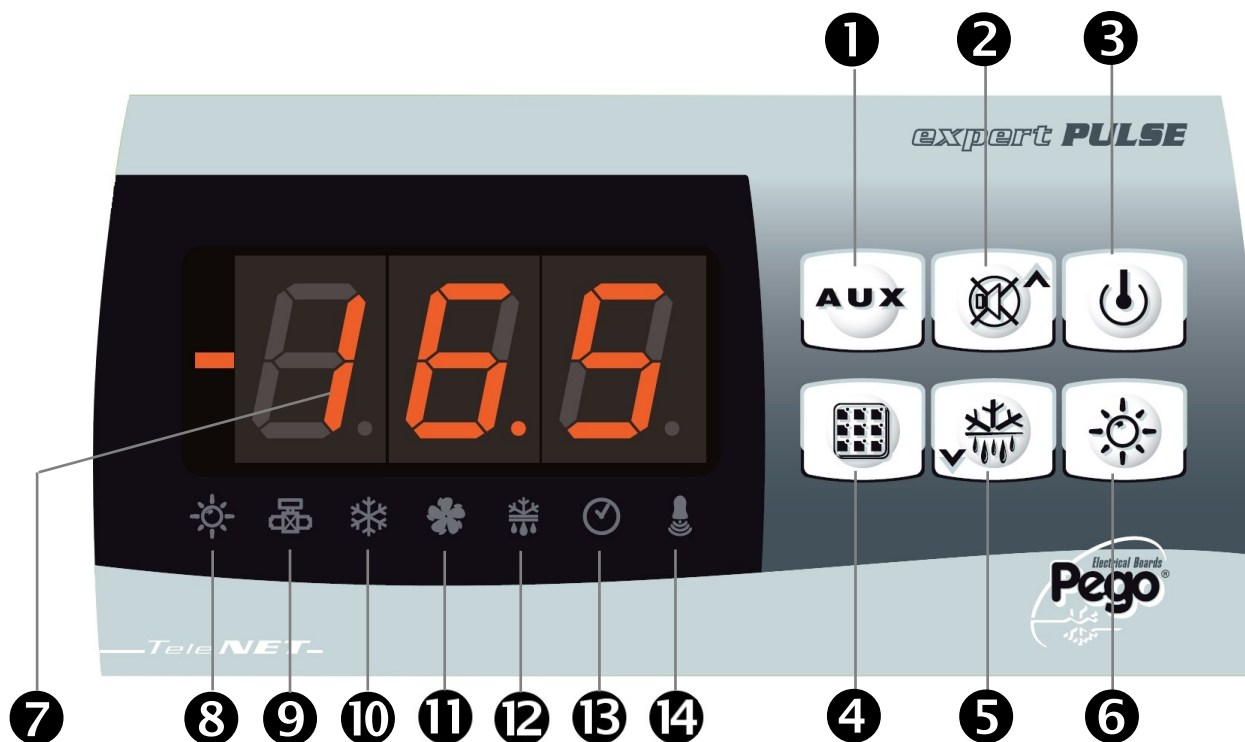

5.1



FRONT KEYBOARD



5.2







KEYBOARD

1		AUXILIARY RELAY COMMAND/VIEWING CURRENT DATE AND TIME Command the relay manually if parameter D05=3 If pressed for 3 seconds it displays the current date/time (when D05≠3).
2		UP / MUTE KEY BUZZER ALARM Increments the values / Scrolls the parameters upwards Mutes the acoustic alarm if included / Acquires an alarm (if the alarm has been resolved and the bell is still on, it can be turned off by pressing this key which acquires the alarm, as with the NANO thermostat) If pressed for 3 seconds at the same time as the stand-by key you can access menu level 3 (EEV parameters) and a BEEP of confirmation will be generated
3		STAND BY Pressed for more than 1 sec. alternates the Stand-by status to normal functioning status, and vice-versa. A confirmation beep is emitted upon occurred change-over. In stand-by status the system stops and the screen displays the word OFF and the temperature alternately. (If included in programming the word OFF will not be displayed alternately)
4		SET AMBIENT TEMPERATURE View the set point Enables setting the set point if pressed at the same time as the Down or UP key Restores audio alarm, if included.

<p>5</p>		<p>DOWN / DEFROST When pressed for more than 3 sec. manual defrost is turned on (if the conditions to turn it on subsist). When pressed for more than 3 sec. during a defrost function, this operation will be terminated. When a defrost function has been inserted / de-inserted manually it will BEEP to confirm.</p>
<p>6</p>		<p>COLD ROOM LIGHT</p>



DISPLAY LED

5.3

<p>7</p>		<p>Value of the ambient temperature / parameters</p>
<p>8</p>		<p>MICRO DOOR / COLD ROOM LIGHT ICON Led OFF = Micro door not Active or not used and cold room light off Led ON = Cold room light ON Flashing Led = Micro door Active and cold room light ON</p>
<p>9</p>		<p>OUTPUT STATUS ICON EEV Output status for the electronic valve EEV (if enabled) Led OFF = EEV output OFF Led ON = EEV output ON</p>
<p>10</p>		<p>COLD CALL / COMPRESSOR DRIVE ICON Led OFF = Cold call OFF Led ON = Cold call ON Flashing Led = Cold call ON but awaiting waiting time C1</p>
<p>11</p>		<p>FANS CALL ICON Led OFF = Fans call OFF Led ON = Fans call ON Flashing led = Fans paused after defrost (see parameter F5)</p>
<p>12</p>		<p>DEFROST CALL ICON Led OFF = Defrost call OFF Led ON = Defrost call ON Flashing led = Dripping in progress after defrost (see parameter d7)</p>
<p>13</p>		<p>REAL TIME CLOCK ICON Led OFF = Defrosting in real time clocks disabled Led ON = Defrosting in real time clocks enabled</p>
<p>14</p>		<p>ALARM PRESENT ICON Led OFF = No alarm present Led ON = Alarm triggered and then resolved (HACCP alarm memorised) Flashing Led = Alarm present</p>

5.4

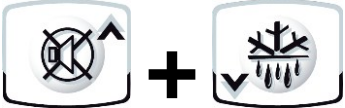
COMBINATION OF KEYS

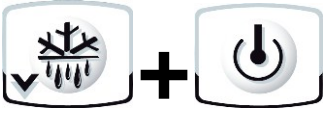
	<p>1ST LEVEL PROGRAMMING If pressed simultaneously for more than 3 sec. they enable access to first level programming menu. A BEEP confirms access to the menu.</p> <p>EXIT FROM PROGRAMMING If pressed simultaneously for more than 3 sec. within any programming menu, they save the settings made exiting the same menu. A BEEP confirms you have exited the menu.</p>
	<p>2ND LEVEL PROGRAMMING If pressed simultaneously for more than 3 sec., they enable access to second level programming menu. A BEEP confirms access to the menu.</p>
	<p>3rd LEVEL PROGRAMMING (EEV parameters) If pressed simultaneously for more than 3 sec., they enable access to third level programming menu. A BEEP confirms access to the menu. entering this menu puts it in stand-by</p>
	<p>QUICK VARIABLES VIEWING MENU (READ ONLY) If pressed simultaneously for more than 3 sec., they enable access to quick variables viewing menu. A BEEP confirms access to the menu.</p> <p>From inside this menu the up and down arrows allow you to view the label and the variables. By pressing the Set key the label and its value are displayed alternately. (in this case it switches: it is not necessary to keep the set key pressed down) When you view the value of the current label you can view the previous or next one by pressing the up or down arrows (you exit value viewing to view the label). You exit this menu automatically after 2 min of keyboard inactivity or by pressing arrow up + arrow down (exit beep of confirmation).</p>

5.5

SETTING AND VIEWING THE SET POINT

1. Press the "Set" key to view the current SETPOINT value (temperature)
2. By holding down the "Set" key and pressing one of the (▲) or (▼) keys you can change the SETPOINT value.
Release the "Set" key to go back to viewing the cold room temperature, any changes will be memorised automatically.

FIRST LEVEL PROGRAMMING (User level)

5.6

To access the first level configuration menu you must:

1. Simultaneously keep keys (▲) and (▼) pressed down for more than 3 seconds until the first programming variable appears on the display. When you enter the menu an acoustic signal will sound if the BUZZER is included.
2. Release keys (▲) and (▼)
3. Select the variable to amend using key (▲) or key (▼).
4. After having selected the wanted variable it will be possible:
 - To display its setting by pressing the SET key
 - To amend the setting by keep the SET key pressed and press one of the (▲) or (▼) keys.

To exit the menu once the configuration values are set, simultaneously keep keys (▲) and (▼) pressed for a few seconds until the cell humidity value appears again. When you exit the menu an acoustic signal will sound if the BUZZER is included.

5. Memorisation of the amendments made to the variables will happen automatically when exiting the configuration menu.

LIST OF FIRST LEVEL VARIABLES (User level)

5.7

VARIA	MEANING	VALUES	DEFAULT
r0	Temperature differential referred to main set point. This is expressed in absolute value and defines the hysteresis (positive if mOd=0 or negative if mOd=1) of the temperature referred to as the SET POINT.	0.2 ÷ 10 °C	2 °C
d0	Interval for defrost (hours) With d0=0 and dFr=0 the Defrosting operations are excluded	0 ÷ 24 hours	4 hours
d2	Set point for the end of defrost. Defrost is not carried out if the temperature read by the defrost probe is greater than the value of d2 (If the probe is broken defrost is performed based on time)	-35 ÷ 45 °C	15°C
d3	Maximum defrost time (minutes)	1 ÷ 240 min	25 min
d7	Dripping time (minutes) At the end of defrosting, the compressor and the fans remain still for the d7 set time, the defrosting led on the front of the panel flashes.	0 ÷ 10 min	0 min
F5	Fans pause after defrosting (minutes) Enables keeping the fans still for an F5 time after dripping. This time starts from the end of dripping. If dripping is not set, at the end of defrosting the fans pause occurs directly.	0 ÷ 10 min	0 min
A1	Minimum temperature alarm The absolute temperature referred to the ambient probe below which, once the Ald delay time is over, the LOW temperature alarm is activated, which consists in activating the Buzzer (if included), with the entry EL which alternates with the temperature on the display screen and the flashing icon indicating the presence of the alarm. When the alarm is resolved the "alarm present" icon stays on (steady) indicating that the repair has been made until you press the UP key. From inside the HACCP menu you can see	-45 ÷ (A2-1) °C	-45°C
A2	Maximum temperature alarm The absolute temperature referred to the ambient probe above which, once the Ald delay time is over, the HIGH temperature alarm is activated, which consists in activating the Buzzer (if included), with the entry EH which alternates with the temperature on the display screen and the flashing icon indicating the presence of the alarm. When the alarm is resolved the "alarm present" icon stays on (steady) indicating that the repair has been made until you press the UP key.	A1+1 ÷ +45 °C	+45°C

dFr	Enabling evaporator defrosting in real time With d0=0 and dFr=1 it is possible to set up to 6 real time defrostings in a single day using parameters d41...d46	0 disabled 1 enabled	0
dF1... dF6	Programming evaporator defrosting times. It is possible to set up to 6 times for defrostings. The time is in the HH.M format where HH represents the hour and M tens of minutes (Ex. 0=0 min; 1=10 min, etc.). The flashing period (.) indicates that a time is being viewed, and not a temperature.	00.0 ÷ 23.5	--

5.8

2nd LEVEL PROGRAMMING (Installer level)

To access second level programming, keep the UP (▲), DOWN (▼) and COLD ROOM LIGHT key pressed for more than 3 seconds. When you enter the menu an acoustic signal will sound if the BUZZER is included. When the first programming variable appears, the system automatically switches to stand-by.

1. Select the variable to amend using key (▲) or key (▼). After having selected the wanted variable it will be possible:
2. To display its setting by pressing the SET key
3. To amend the setting by keep the SET key pressed down and press one of the (▲) or (▼) keys
4. Once configuration values have been set, to exit the menu press (▲) and (▼) simultaneously keeping them pressed for a few seconds, until the temperature value appears. When you exit the menu an acoustic signal will sound if the BUZZER is included.
5. Memorisation of the amendments made to the variables will happen automatically when exiting the configuration menu.
6. Press the STAND-BY key to enable electronic control.

5.9

LIST OF 2nd LEVEL VARIABLES (Installer level)

VARIABLES	MEANING	VALUES	DEFAULT
F3	Fans status with compressor off	0 = Fans in continuous start 1 = Fans running only when the compressor is running 2 = fans DISABLED (this also disables the display icon)	1
F4	Fans pause during defrosting	0 = Fans working during defrosting 1 = Fans not working during defrosting	1
Fst	FAN blocking TEMPERATURE The fans do not switch on if the value of the temperature read by the evaporator probe is higher than the value of this parameter. The block is deactivated when the evaporator probe is disabled or presents an error.	-45...+45°C	+45°C
Fd	Differential for Fst	1...+10°C	2°C
dE	Probe included By excluding the evaporator probe defrosting will be performed cyclically with a period of d0 and will terminate when the time expires on d3.	0 = evaporator probe included 1 = evaporator probe not included	0
d1	Type of defrosting , at cycle inversion (hot gas) or resistance	1 = with hot gas 0 = with resistance	0
C1	Minimum amount of time between switch off and the next Time the compressor is switched on.	0...15 min	0 min

<i>CE1</i>	Operating time ON for the compressor in case of broken ambient probe (Emergency function) With CE1=0 the emergency function with an E0 error remains disabled, the compressor stays off and defrosting is inhibited in order to preserve the residual cold.	0...240 min 0 = disabled	0
<i>CE2</i>	Operating time OFF for the compressor in case of broken ambient probe (Emergency function)	5...240 min	5
<i>doC</i>	compressor guarding time for the micro door , when the micro door opens the evaporator fans switch off and the compressor will continue operating for the amount of time of doC , then it will switch off	0...5 minutes	0
<i>tdo</i>	Re-insert compressor time after opening the door. When the micro door opens and the tdo time is up the normal operation of the control will be restored and the open door alarm (Ed) will be sound With tdo=0 the parameter is disabled.	0...240 minutes 0 = disabled	0
<i>In1</i>	Digital input DI1 and activation status setting.	7= Pump-down pressure switch (N.O.) 6= Stop defrosting from remote (N.O.) (The up impulse front is taken) 5= Start defrosting from remote (N.O.) (The up impulse front is taken) 4= Stand-by from remote (N.O.) (To indicate remote stand-by IN4 will be viewed on the display alternately with the current view) 3= person in refrigerator alarm (N.O.) 2= Micro door (N.O.) 1= compressor protection (N.O.) 0= Disabled -1= compressor protection (N.C.) -2= Micro door (N.C.) -3= man in cold room alarm (N.C.) -4= Stand-by from remote (N.C.) (To indicate remote stand-by IN4 will be displayed alternately with the current view) -5= Start defrosting from remote (N.C.) (The down impulse front is taken) -6= Stop defrosting from remote (N.C.) (The down impulse front is taken) -7= Pump-down pressure switch (N.C.)	1
<i>In2</i>	Digital input DI2 and activation status setting.	7= Pump-down pressure switch (N.O.) 6= Stop defrosting from remote (N.O.) (The up impulse front is taken) 5= Start defrosting from remote (N.O.) (The up impulse front is taken) 4= Stand-by from remote (N.O.) (To indicate remote stand-by IN4 will be viewed on the display alternately with the current view) 3= man in cold room alarm (N.O.) 2= Micro door (N.O.) 1= compressor protection (N.O.) 0= Disabled -1= compressor protection (N.C.) -2= Micro door (N.C.) -3= man in cold room alarm (N.C.) -4= Stand-by from remote (N.C.) (To indicate remote stand-by IN4 will be displayed alternately with the current view) -5= Start defrosting from remote (N.C.) (The down impulse front is taken)	2

		-6= Stop defrosting from remote (N.C.) (The down impulse front is taken) -7= Pump-down pressure switch (N.C.)	
DO5	Digital output DO5 functioning setting. Configurable auxiliary / alarm relay (OUTPUT WITH CLEAN CONTACT)	<p>5= automatic auxiliary relay managed by the StA temperature set referred to the st0 probe with a 2°C differential (this function does not display the relay status on the display screen)</p> <p>4= Relay DO5 is excited with an active cold request (evaporator solenoid). In this configuration the DO1 output was activated by the In1 or In2 digital input configured as Pump-down pressure switch (In1 or In2=7 or -7).</p> <p>3= auxiliary relay switches with the AUX button (switching and viewing the relay status is made on the display screen. If DO5=3 by pressing the AUX key the relay status is displayed with the words AOn if excited or AOF if not excited. The writing on the screen will be displayed for 2 seconds after the button is released. If the AUX button is pressed for 3 seconds it switches the status from AOn to AOF or vice versa (flip flop) and a BEEP will sound to signal the switch.</p> <p>2= Relay DO5 excited with excited compressor output DO1. Used to call condensing unit.</p> <p>1= Relay DO5 excited in presence of alarm 0= RelayDO5 Disabled -1= Relay DO5 de-excited in presence of alarm -2= Relay DO5 de-excited with excited compressor output DO1. Used for the casing resistance command. This output also remains active when the QE is in STAND-BY.</p>	1
<i>StA</i>	Set temperature for the auxiliary relay	-45...+45°C	0
<i>LSE</i>	Minimum value attributable to set point	-45 ÷ HSE-1 °C	-45°C
<i>HSE</i>	Maximum value attributable to set point	+45 ÷ LSE+1 °C	+45°C
<i>CAL</i>	ambient probe value correction	-10,0...+10,0	0,0
<i>Ald</i>	Signal delay and alarm display time of minimum or maximum temperature.	1...240 min	120 min
<i>Ad</i>	Network address to connect to the TeleNET or Modbus supervision system	0 ÷ 31 (with SER=0) 1 ÷ 247 (with SER=1)	0
<i>SER</i>	Communication protocol on RS-485	0= TeleNET protocol 1= Modbus-RTU protocol	0

<i>PI</i>	Password: type of protection (active when PA is different from 0).	<p>0 = displays only the set point and allows you to silence the alarms</p> <p>1 = displays the set point, allows you to silence the alarms, + defrost + light + aux key + menu with read-only access to the variables</p> <p>2= access blocks in programming for levels 1 and 2 and 3 (all other functions are allowed)</p> <p>3= access blocks in programming for levels 2 and 3 (all other functions are allowed)</p> <p>4= access blocks in programming for level 3 (all other functions are allowed)</p>	3
<i>PA</i>	Password (see P1 for the type of protection)	0...999 0 = deactivated function	0
<i>Yr</i>	Set the year	0...99	
<i>Mo</i>	Set the month	1...12	
<i>dy</i>	Set the day	1...31	
<i>Hr</i>	Set the time	0...23	
<i>min</i>	Set the minutes	0...59	
<i>reL</i>	release software	read only	read only

5.10

3rd LEVEL PROGRAMMING (EEV PARAMETERS)

To access third level programming, keep the UP (▲) and STAND-BY keys pressed for more than 3 seconds. When the first programming variable appears, the system automatically switches to stand-by.

1. Select the variable to amend using key (▲) or key (▼). After having selected the wanted variable it will be possible:
2. To display its setting by pressing the SET key
3. To amend the setting keep the SET key pressed down and press one of the (▲) or (▼) keys.
4. Once configuration values have been set, to exit the menu press the (▲) and (▼) keys simultaneously keeping them pressed for a few seconds, until the temperature value appears.
5. Memorisation of the amendments made to the variables will happen automatically when exiting the configuration menu.
6. Press the STAND-BY key to enable electronic control.

5.11

LIST OF 3rd LEVEL VARIABLES (EEV PARAMETERS)

VARIABLES	MEANING	VALUES	DEFAULT
ESH	Overheating set point.	0.1...+25.0 °C (increments of 0.1 °C)	6.0°C
EEV	<p>Electronic valve EEV management With EEV=0 all controls and relative alerts are disabled. Relative errors for probe S3 (Extraction temperature) and S4 (Evaporation pressure) are also disabled and excluded</p> <p>The settings from 1 to 4 load default values in the <i>ECt</i>, <i>EPb</i>, <i>EtI</i>, <i>Etd</i>, <i>ELS</i> variables</p> <p>When you exit programming if the selected value for EEV is different from the one that was previously memorised the relative defaults for this selection will be loaded. Pressing only the Set key to see the current value for EEV will not load the defaults.</p>	0 = disabled 1 = EEV control (default 1) 2 = EEV control (default 2) 3 = EEV control (default 3) 4 = EEV control (default 4) 5 = EEV control (default 5)	1
ErE	<p>Type of refrigerant GAS employed. Setting this parameter is essential for correct operation.</p>	0 = 404 1 = 134 2 = R22 3 = 407 4 = 410 5 = 507 6 = CO2	0
ECt	<p>Cycle time This represents the sum of EEV valve opening / closing cycle times. This is used to calculate the EEV opening and closing times.</p> <p>Example: if the EEV valve must be opened by 30% we will have: EEV valve opening time = ECt* 30/100 EEV valve closing time = ECt * (100-30)/100</p>	1-20 sec	6 sec

EPb	Proportional band (gain) PID overheating adjustment.	1...100%	15%
EtI	Integral time PID overheating adjustment algorithm	0-500 sec 2-second steps	100 sec
Etd	Derivative time PID overheating adjustment algorithm	0.0-10.0 sec 0.1-second steps	2.0 sec
EOE	Percentage of the EEV valve opening in case of error with probes S3 or S4. This function allows you to continue with the adjustment, although not in an optimal fashion, in case the adjustment probes breakdown.	0...100%	50%
ESO	During the Start phase the EEV valve opens as far as the ESO percentage and for the ESt time	0...100%	85%
ESt	During the Start phase. In this phase the MOP, LOP, LSH alarms are disabled.	0-Edt tens of seconds	6 tens of seconds
EdO	After Defrost the EEV valve opens as far as EdO percentage for the Edt time.	0...100%	100%
Edt	During the opening phase of the EdO valve after Defrost. In this phase the MOP, LOP, LSH alarms are disabled.	Est-250 tens of seconds .	24 tens of seconds
EHO	Maximum percentage for the EEV valve opening: If the valve is oversized this variable allows you to limit the maximum opening and the set percentage.	0...100%	100%
EPP	Type of pressure transducer (S5): set the type of transducer used to detect the Evaporation pressure (S5)	0 = 4÷20mA-type pressure transducer connected to the instrument 1= ratiometric 0-5V-type pressure transducer connected to the instrument	0
EP4	Pressure (bar) corresponding to 4mA or to 0V Referred to the Evaporation pressure probe (S5).	(-1.0 ÷ (EP2-0.2) bar) (in any case EP4<=24.5)	0.0
EP2	Pressure (bar) corresponding to 20mA or to 5V Referred to the Evaporation pressure probe (S5).	(EP4 ÷ 50.0 bar) increments of 0.2 (in any case EP2>=0)	12.0
CA4	Calibration of the Extraction temperature transducer (S4)	-10.0...+10.0 °C	0,0
CA5	Calibration of the Evaporation pressure transducer (S5)	-10,0...+10,0 Bar	0,0
LSH	LSH threshold (Low overheating temperature) Overheating values that are too low can cause liquid to return to the compressor or strong oscillations. Below the LSH value the ELS protection intervenes and acts by increasing the PID speed when closing the valve to reach the set overheating set.	0... Set SH °C	2 °C
ELS	LSH protection If enabled, when tSH < LSH the integration time for the PID is set based on the ELS selection from 1 to 7. The setting of 1 is the setting that generates a quicker closing. When this protection is entered the SHd count for LSH alarm activation will begin. THE LSH PROTECTION HAS PRIORITY OVER THE LOP PROTECTION LSH PROTECTION IS NOT ACTIVATED DURING THE START PHASE (ESt TIME), DURING THE DEFROST OR POST-DEFROST PHASE (Edt TIME)	0= disables the protection LSH and relative LSH alarm alert 1= 5% EtI 2= 10% EtI 3= 15% EtI 4= 20% EtI 5= 25% EtI 6= 30% EtI 7= 35% EtI 8= 50% EtI 9= 100% EtI (no correction and only the LSH alarm is active)	2

<i>SHd</i>	<p>Delay in activating the LSH alarm: the LSH overheating alarm is signalled only after it has been active for the amount of the SHd time. In case of an LSH alarm, the valve closing is nevertheless instantaneous;</p> <p>The alarm is self-restoring and stops when $tSH \geq LSH$</p> <p>With an active alarm, you have:</p> <ul style="list-style-type: none"> - Flashing LSH written on the display screen - Buzzer 	(0 ÷ 240 tens of seconds)	30
<i>MOP</i>	<p>MOP threshold (Maximum saturated evaporation Temperature referred to the sensor S5)</p> <p>This represents the maximum evaporation pressure, expressed in saturated degrees, and activates the MOP protection when it is exceeded (EMO parameter). If the MOP kicks in the control will close the valve gradually to limit the evaporation temperature and avoid the compressor from stopping for thermal protection.</p>	(LOP+1) ...+45°C	+45°C
<i>EMO</i>	<p>MOP protection (active with $tS5 > MOP$)</p> <p>With MOP protection on the valve abandons its control PID and at any other cycle time it closes as established by the EMO percentage starting from the opening percentage of the abandoned PID.</p> <p>When this protection is entered the MOP count for MOP alarm activation will begin.</p> <p>THE MOP PROTECTION IS NOT ACTIVATED DURING THE START PHASE (Est TIME), DURING THE DEFROST OR POST-DEFROST PHASE (Edt TIME)</p>	<p>0 = disables the MOP protection and relative MOP alarm alert</p> <p>0...100%</p>	0
<i>MOd</i>	<p>Delay in activating the MOP alarm: the MOP alarm is signalled only once the MOP protection has been active for the amount of the MOd time.</p> <p>The alarm is self-restoring when "$Temp.S5 \leq MOP$"</p> <p>With an active alarm, you have:</p> <ul style="list-style-type: none"> - Flashing MOP written on the display screen - Buzzer 	(0 ÷ 240 tens of seconds)	60
<i>LOP</i>	<p>LOP threshold (Minimum saturated evaporation Temperature referred to the sensor S5)</p> <p>This represents the minimum evaporation pressure, expressed in saturated degrees, and activates the LOP protection when it falls below this value. In case of LOP the control opens the valve to avoid the compressor from stopping due to low pressure (mechanical pressure switch).</p>	-45°C .. (MOP-1)	-45°C
<i>ELO</i>	<p>LOP protection (active with $tS5 > LOP$)</p> <p>With LOP protection on the valve abandons its control PID and at any other cycle time it opens as established by the ELO percentage starting from the opening percentage of the abandoned PID.</p> <p>When this protection is entered the LOd count for LOP alarm activation will begin.</p> <p>THE LSH PROTECTION HAS PRIORITY OVER THE LOP PROTECTION</p> <p>THE LOP PROTECTION IS NOT ACTIVATED DURING THE START PHASE (Est TIME), DURING THE DEFROST OR POST-DEFROST PHASE (Edt TIME)</p>	<p>0=disables the LOP protection and relative LOP alarm alert</p> <p>0...100%</p>	0

Lod	<p>Delay in activating the LOP alarm: the LOP alarm is signalled only once the LOP protection has been active for the amount of the LOd time.</p> <p>The alarm is self-restoring when "Temp.S5" \geq LOP</p> <p>With an active alarm, you have:</p> <ul style="list-style-type: none"> - Flashing LOP written on the display screen - Buzzer 	(0 ÷ 240 tens of seconds)	30
------------	--	---------------------------	----

Note: all calculation times for the LSH, MOP, LOP alarms are reset when adjustment is complete OR DURING THE START PHASE (Est TIME), DURING THE DEFROST OR POST-DEFROST PHASE (Edt TIME)

Loading default settings based on the EEV variable:

5.12

	EEV = 1 PEGO DEFAULT	EEV = 2 (COLD ROOM or TN REFRIGERATOR CASE control with built-in compressor)	EEV = 3 (COLD ROOM or BT REFRIGERATOR CASE control with built-in compressor)	EEV = 4 (COLD ROOM or CHANNELED TN REFRIGERATOR CASE control)	EEV = 5 (COLD ROOM or CHANNELED BT REFRIGERATOR CASE control)
ESH	6 °C	6 °C	6 °C	11 °C	11 °C
EPb	15 %	15 %	15 %	15 %	15 %
EtI	100 sec	100 sec	100 sec	150 sec	150 sec
Etd	2 sec	2 sec	2 sec	5 sec	5 sec
LSH	2 °C	2 °C	2 °C	5 °C	5 °C
ELS	2	2	2	2	2
MOP	+45 °C	5 °C	-15 °C	+5 °C	-15 °C
EMO	0	5	5	5	5
LOP	-45 °C	-25 °C	-45 °C	0	0
ELO	0	15	15	0	0

5.13

QUICK VARIABLES VIEWING MENU (READ ONLY)

During system start-up it can be useful to check the reading of the various probes or a number of values in a simple fashion, or optimise the process.

To access quick variables viewing menu, keep the DOWN (▼) and STAND-BY keys pressed for more than 3 seconds.

From inside this menu the up or down arrows allow you to view the label and the variables.

By pressing the Set key the label and its value are displayed alternately. (To make the reading easier press the set key to switch from label to value: it is not necessary to keep the set key pressed down)

When you view the value of the current label you can view the previous or next one by pressing the up or down arrows (you exit value viewing to view the label).

You exit this menu automatically after 2 min of keyboard inactivity or by pressing arrow up + arrow down.

5.14

LIST OF VARIABLES QUICK VIEWING MENU (READ ONLY)

<i>VARIABLES</i>	<i>MEANING</i>	<i>VALUES</i>
<i>tS0</i>	View Ambient Temperature probe (S0)	(read only) °C
<i>tS1</i>	View Defrost Temperature probe (S1)	(read only) °C
<i>tS4</i>	View Extraction Temperature probe (S4)	(read only) °C
<i>tS5</i>	View Evaporation Temperature probe (S5)	(read only) °C
<i>PS5</i>	View Evaporation Pressure probe (S5)	(read only) Bar
<i>tSH</i>	View Overheating temperature $tSH = tS4 - tS5$	(read only) °C
<i>oEV</i>	percentage of EEV valve opening	(read only) %

THERMOSTAT OPERATING MODE

5.15

The mOd variable allows you to choose the operating mode for the thermostat, in particular:
CHILL CALL MODE

The DO1 output is activated when the temperature measured by the Ambient probe reaches or exceeds the SET POINT+r0 value and stays active until the temperature falls below the SET POINT.

This way the DO1 output mode is coordinated with the chill call icon switching on.

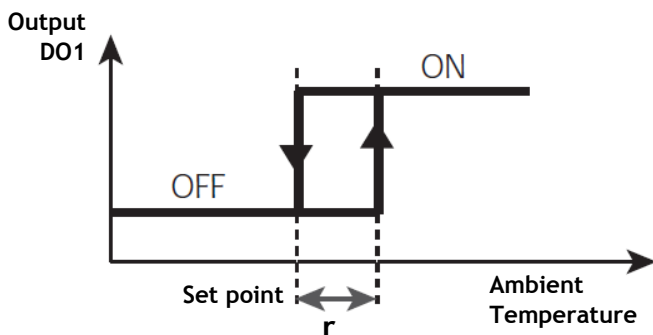

PASSWOD FUNCTION

5.16

The password function activates by setting a value different from 0 for parameter PA. See parameter P1 for the different protection levels.

Protection is enabled automatically after approx. 30 minutes of inactivity on the keyboard.

The digits 000 appear on the display screen. Use the up/down keys to change the number and the SET key to confirm it.

The mask to enter the password 000 disappears if you do not use the keyboard within 30 seconds

If password is forgotten use universal number 100.

EMERGENCY FUNCTION WHEN ERROR E0 OCCURS
(AMBIENT PROBE OUT OF ORDER)

5.17

This safety mode guarantees the compressor will operate even if the ambient probe is not working (error E0).

With probe error E0 and CE1 other than 0, the compressor works in work pause mode, with compressor ON for the amount of time of CE1 and OFF for the amount of time of CE2.

With CE1>0, when error E0 occurs defrosting will be managed as in the normal mode of operation.

With CE1=0, the emergency operation with an E0 error stays disabled: the compressor stays off and defrosting is inhibited per preserve the residual cold,

Eliminate the cause of error E0 as soon as possible and reactivate normal control operations to adjust the temperature correctly.

MANUAL DEFROST ACTIVATION

5.18

To activate defrost simply press the DOWN key for more than 4 seconds; this will activate the relay for resistances. Defrosting is not activated if conditions for activation are not met (the set temperature to terminate defrosting (d2), is lower than the temperature detected by the evaporator probe).

Defrosting will terminate when the terminate defrost temperature has been reached (d2) or for the maximum duration of defrost (d3) or when terminate defrost is forced manually (terminate defrost key or digital input).

5.19**MANUALLY FORCE TERMINATE DEFROST IN PROGRESS**

When defrost is in progress press the DOWN button for 4 seconds to force defrost in progress to terminate. When terminating defrost manually the drip phase is also skipped.

5.20**HOT GAS DEFROST**

Set parameter d1 = 1 for managing cycle inversion defrosting.

The compressor relay and the defrosting relay are activated for the entire defrosting phase (defrost).

For the correct management of the plant, it will be the responsibility of the installer to use the defrost output, that must allow the opening of the cycle inversion solenoid valve and the closing of the liquid solenoid valve.

For the capillary plants (without thermostatic valve) it is sufficient to control the cycle inversion electrovalve using the defrosting relay control (defrost).

5.21**VIEW TEMPERATURE AMBIENT AFTER DEFROSTING**

After defrost the display screen will continue to display the last value for the ambient temperature read prior to defrost, for 1 minute.

5.22**PUMP DOWN FUNCTION**

By setting the parameter In1 or In2 = 7 or -7 the stop compressor in pump down function will be activated. The digital input will become the work pressure switch input and will manage the compressor output directly

The chill call will only act on the EEV solenoid output.

CHAPTER 6: OPTIONAL KITS

TELENET MONITORING AND SUPERVISION SYSTEM

6.1

For **TeleNET** connections to enable RS485 follow the scheme below. Refer to **TeleNET** user manual for instrument configuration.

WARNING: During configuration, at entry "Module" to select the entry "Instrument ECP200EEV".

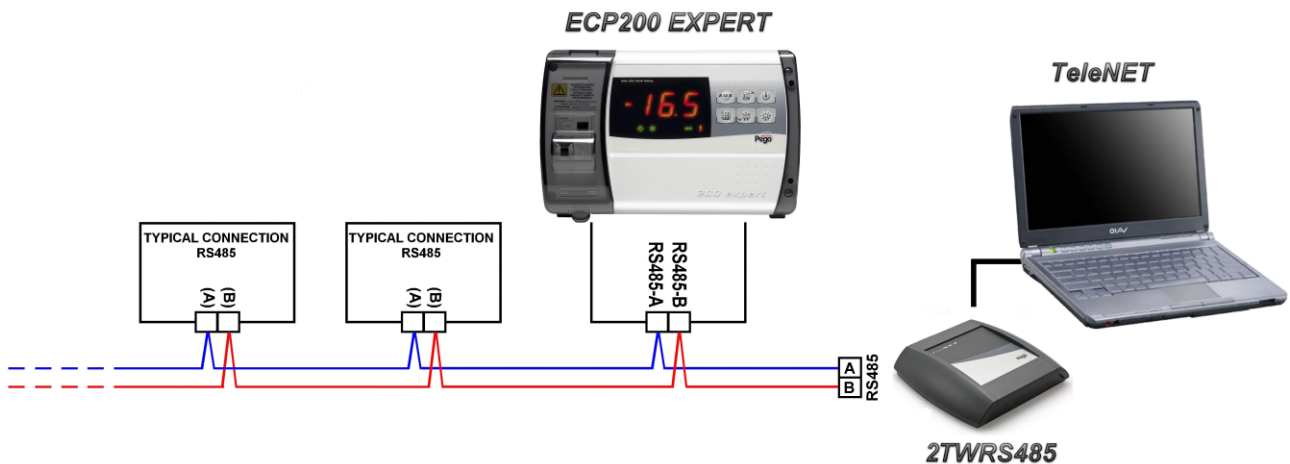

NET CONFIGURATION WITH MODBUS-RTU PROTOCOL

6.2

For **RS485** connections with **Modbus-RTU** protocol, to enable RS485 output follow the scheme below.

Refer to MODBUS-RTU_ECP200T1 user manual (available on Pego Internet web site) for MODBUS-RTU communication protocol specification.

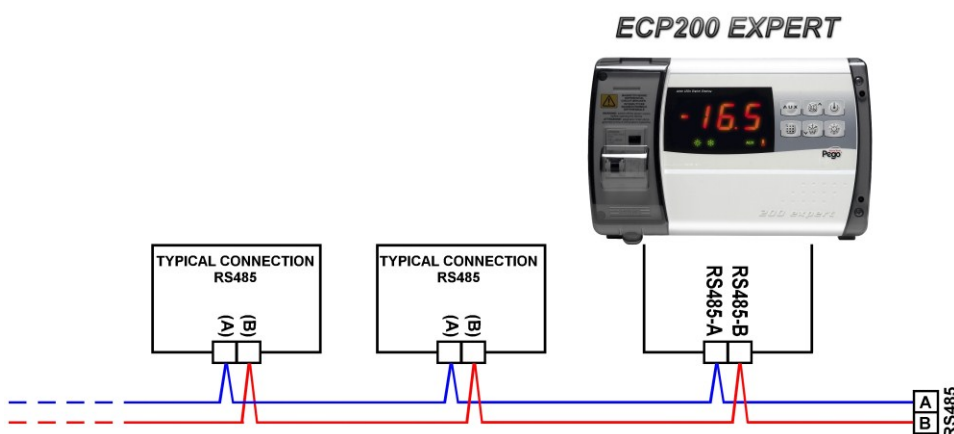

CHAPTER 7: DIAGNOSTICS

7.1

DIAGNOSTICS

In case of anomaly, the ECP200 EXPERT controller will alert the operator through the alarm codes displayed on the screen and with an acoustic signal emitted by a buzzer (if included).

The acoustic alarm can be switched off by pressing the UP key (the error code remains) and can be reactivated by pressing the SET key.

If an alarm condition arises, one of the following messages will appear on the display screen:

ALARM CODE	POSSIBLE CAUSE	OPERATION TO BE PERFORMED
<i>E0</i>	Functional anomaly of the ambient probe (S0)	<ul style="list-style-type: none"> Check that cold room temperature sensor is working properly If the problem persists replace the sensor
<i>E1</i>	Functional anomaly of the defrosting probe (S1) (In this case any defrosting will last for the amount of time established by d3).	<ul style="list-style-type: none"> Check that cold room temperature sensor is working properly If the problem persists replace the sensor
<i>E4</i>	Functional anomaly of the Extraction temperature probe (S4)	
<i>E5</i>	Functional anomaly of the Evaporation Pressure probe (S5)	
<i>EE</i>	EEPROM alarm An error has been found in the EEPROM memory. (All of the outputs have been deactivated except for the alarms, if configured)	<ul style="list-style-type: none"> Switch unit off and back on
<i>E6</i>	Low battery alarm ; the control will work for at least 20 more days, after which time, if there is no longer a power supply to the panel the time setting will be lost.	
<i>E8</i>	Man in cold room alarm The man in cold room alarm button was pressed from inside the cold room to signal a hazardous situation.	<ul style="list-style-type: none"> Reset the alarm input inside the cold room
<i>E9</i>	Alarm cold room light. Turning on the light with the key, spent the tdo time the alarm E9 goes off. If it is silenced and is not turned off the light, after a new time tdo, the alarm recurs.	
<i>Ec</i>	Insert compressor protection (ex. Thermal protection or max. pressure switch) (All of the outputs have been deactivated except for the alarm, if configured)	
<i>Ed</i>	Door open alarm. When the micro door opens and the tdo time is up the normal operation of the control will be restored and the open door alarm (Ed) will be sound	<ul style="list-style-type: none"> Check door switch status Check door switch connections If the problem persists contact the technical assistance service
<i>EL</i>	Minimum temperature alarm The words EL flash alternately with the temperature (See parameter A1)	

<i>EH</i>	Maximum temperature alarm. The words EH flash alternately with the temperature (See parameter A2)	
<i>LSH</i>	Low overheating temperature alarm	
<i>MOP</i>	Maximum saturated evaporation temperature alarm referred to sensor S4	
<i>LOP</i>	Minimum saturated evaporation temperature alarm referred to sensor S4	

APPENDICES

A.1

EC declaration of conformity

COSTRUTTORE / MANUFACTURER:



PEGO S.r.l. Via Piacentina, 6/b 45030 Occhiobello (RO) – Italy –
Tel. (+39) 0425 762906 Fax. (+39) 0425 762905

DENOMINAZIONE DEL PRODOTTO / NAME OF THE PRODUCT:

MOD.: ECP200 EXPERT EEV

IL PRODOTTO E' CONFORME ALLE SEGUENTI DIRETTIVE CE:

THE PRODUCT IS IN CONFORMITY WITH THE REQUIREMENTS OF THE FOLLOWING EUROPEAN DIRECTIVES:

Direttiva Bassa Tensione (LVD): **2014/35/UE**
Low voltage directive (LVD): **2014/35/EU**

Direttiva EMC: **2014/30/CE**
Electromagnetic compatibility (EMC): **2014/30/EU**

LA CONFORMITA' PRESCRITTA DALLA DIRETTIVA E' GARANTITA DALL'ADEMPIMENTO A TUTTI GLI EFFETTI DELLE SEGUENTI NORME (comprese tutte le modifiche):
THE CONFORMITY WITH THE REQUIREMENTS OF THIS DIRECTIVE IS TESTIFIED BY COMPLETE ADHERENCE TO THE FOLLOWING STANDARDS (including all amendments):

Norme armonizzate: EN 60730-1:2011, EN 60730-2-9:2010, EN 61000-6-1:2007, EN 61000-6-3:2007
European standards: EN 60730-1:2011, EN 60730-2-9:2010, EN 61000-6-1:2007, EN 61000-6-3:2007

IL PRODOTTO E' COSTITUITO PER ESSERE INCORPORATO IN UNA MACCHINA O PER ESSERE ASSEMBLATO CON ALTRI MACCHINARI PER COSTITUIRE UNA MACCHINA CONSIDERATE DALLA DIRETTIVA: 2006/42/CE "Direttiva Macchine".

THE PRODUCT HAS BEEN MANUFACTURED TO BE INCLUDED IN A MACHINE OR TO BE ASSEMBLED TOGETHER WITH OTHER MACHINERY TO COMPLETE A MACHINE ACCORDING TO DIRECTIVE: EC/2006/42 "Machinery Directive".

Occhiobello (RO), 01/04/2016

Paolo Pegorari
Rappresentante Legale

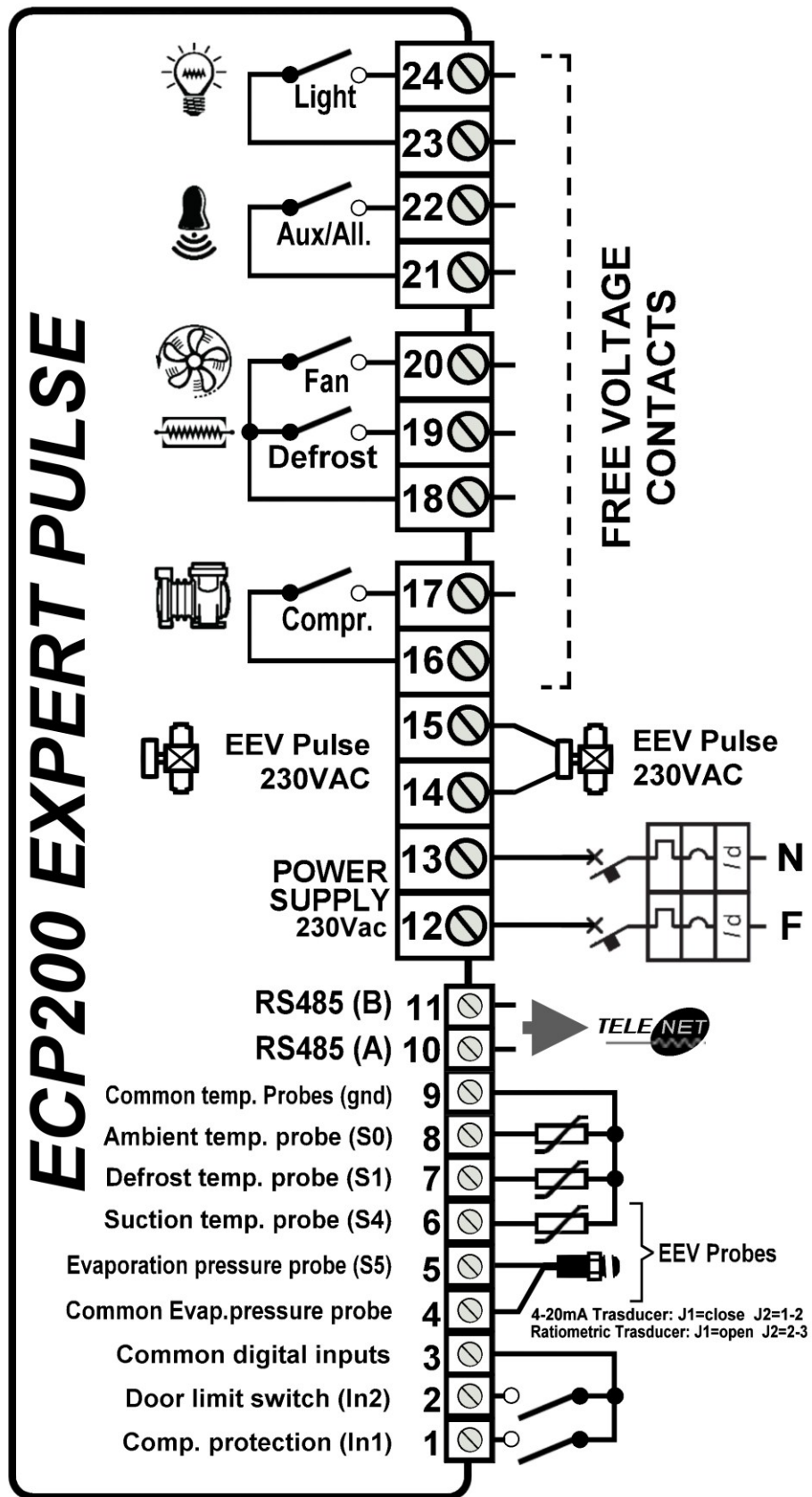

A.3

Part list

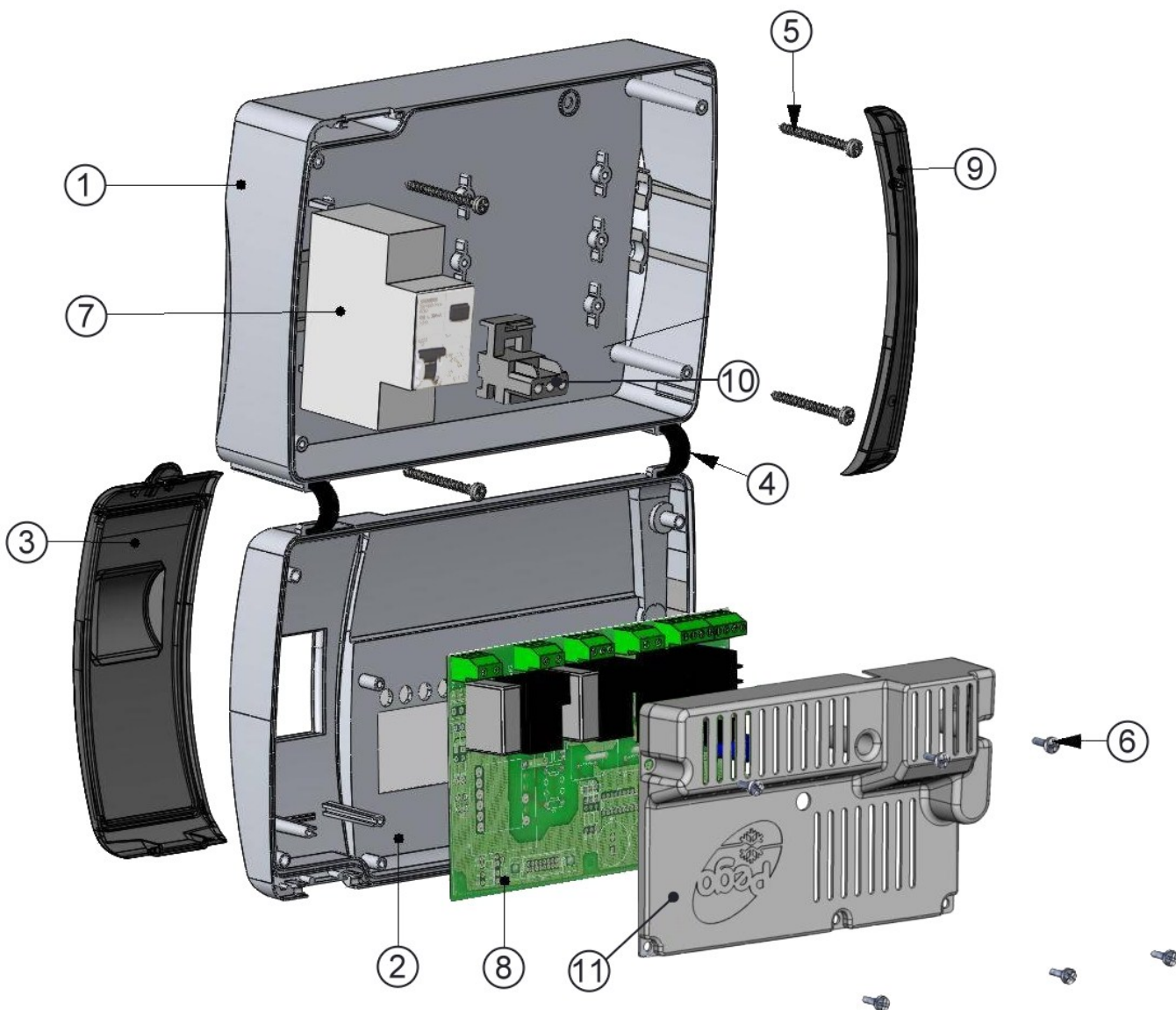

LEGEND

REF.	DESCRIPTION
1	BOX REAR IN ABS
2	BOX FRONT IN ABS
3	FRONT COVER IN TRANSPARENT POLYCARBONATE
4	BOX FRONT OPENING HINGE
5	BOX CLOSURE SCREWS
6	BOARD FIXING SCREWS
7	MAGNETO-THERMAL CUT-OUT / POWER BREAKER
8	CPU BOARD
9	POLYCARBONATE SCREW COVER
10	TERMINAL FOR EARTH CONNECTIONS
11	COVER PROTECTION BOARD



PEGO S.r.l.

Via Piacentina, 6/b

45030 OCCHIOBELLO –ROVIGO-

Tel : 0425 762906

Fax: 0425 762905

www.pego.it

e-mail: info@pego.it

Distributor: