

ECP200 EXPERT 2EV



User and maintenance manual

READ AND RETAIN

ENGLISH

CONTENTS

INTRODUCTION

CHAP. 1

Page 3	1.1	General
Page 4	1.2	Product identification codes
Page 4	1.3	Overall dimensions
Page 4	1.4	Identification data

INSTALLATION

CHAP. 2

Page 5	2.1	General installation rules
Page 5	2.2	Standard equipment for mounting and use
Page 6	2.3	Board installation

TECHNICAL CHARACTERISTICS

CHAP. 3

Page 8	3.1	Technical characteristics
--------	-----	---------------------------

TERMS OF THE WARRANTY

CHAP. 4

Page 9	4.1	Terms of the warranty
--------	-----	-----------------------

DATA PROGRAMMING

CHAP. 5

Page 10	5.1	The control panel
Page 10	5.2	The front keypad
Page 11	5.3	LED display
Page 12	5.4	General
Page 12	5.5	Symbols
Page 12	5.6	Configuring and reading the set point
Page 13	5.7	Level one programming
Page 13	5.8	List of level one variables
Page 15	5.9	Level two programming
Page 15	5.10	List of level two variables
Page 18	5.11	HACCP alarm management
Page 19	5.12	Starting up the ECP200 EXPERT 2EV electronic controller
Page 19	5.13	Configurations
Page 19	5.14	Conditions for enabling / disabling the compressor
Page 19	5.15	Manual activation of the defrosting process
Page 20	5.16	Stopping the defrosting process manually
Page 20	5.17	Defrosting with hot gas
Page 20	5.18	The Pump-Down function
Page 21	5.19	The password function
Page 21	5.20	Emergency operation in the event of a broken ambient sensor (EO)
Page 21	5.21	Current date and time

OPTIONS

CHAP. 6

Page 22	6.1	TeleNET supervision / monitoring system
---------	-----	---

DIAGNOSTICS

CHAP. 7

Page 23	7.1	Diagnostics
---------	-----	-------------

ANNEXES

Page 24	A.1	CE declaration of conformity
Page 25	A.2	ECP200 EXPERT 2EV connection diagram
Page 26	A.3	Exploded diagram

CHAPTER 1: INTRODUCTION

GENERAL

1.1

DESCRIPTION:

The **ECP200 EXPERT 2EV** is the new electrical board for cold rooms with single-phase compressor up to 2HP and up to 2 evaporating units.

It allows complete control of all the components on a refrigeration system such as the compressor, the evaporator fans, defrosting element 1, defrosting element 2, room light and configurable auxiliary relay.

APPLICATIONS:

- Room with single motor condenser up to 2HP and double evaporating unit.
- Complete control of single-phase static or ventilated refrigeration systems up to 2HP, with off-cycle or electrical defrosting and direct or pump-down compressor stop.
- Control of evaporating unit only with freon solenoid consensus or remote motor condenser consensus.

MAIN CHARACTERISTICS:

- Reading and configuration of the room temperature to one decimal point.
- Displays temperature parameter of evaporator 1 and 2
- Activation/deactivation of the system controller (stand-by)
- Signalling of system alarms
- System status LEDs and large display
- Easy to use keypad
- Control of the evaporator fans
- Real time clock defrosts with one or two evaporators, each with end-of-defrost sensor.
- Automatic and manual defrost control (static, with elements, with cycle inversion)
- Management and control (direct or in pump-down mode) of the compressor up to 2HP
- Button on board or door switch for turning on the room light
- Alarm/auxiliary relay with parameter-configured activation.
- Advanced HACCP function with detailed registration of the last temperature alarm to have occurred, and counter for previous alarms.
- Integrated differential thermal magnetic circuit breaker for protecting and turning off the power to the refrigerating unit (to make the protection effective, derive the power supply of the utilities downstream of the differential thermal magnetic circuit breaker).
- Self-extinguishing ABS cover with transparent door for accessing the thermal magnetic differential protection with IP65 protection, for use as a board outside the room.
- RS485 output for connection to TeleNET supervision network.

1.2

PRODUCT IDENTIFICATION CODES

code 200200EXP2EV

ECP200 EXPERT 2EV

Compressor control and management, evaporator 1 defrost, evaporator 2 defrost, evaporator fans and room light. Alarm/aux relay. Real time clock. 16A differential thermal magnetic circuit breaker Id=300mA

1.3

OVERALL DIMENSIONS

dimensions in mm.



1.4

IDENTIFICATION DATA

There is a plate on the device in question that states the identification data:

- Name of the manufacturer
- Code and model of the device's electrical board
- Serial number
- Power supply
- Max rated current
- IP protection

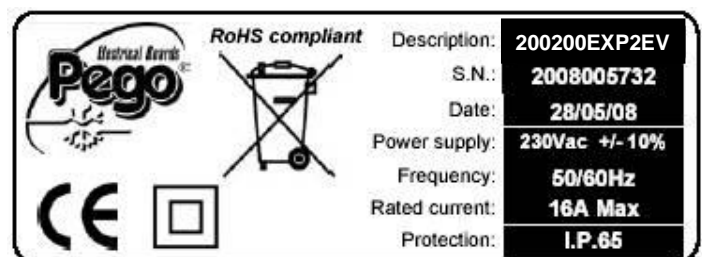

CHAPTER 2: INSTALLATION

GENERAL INSTALLATION RULES

2.1

1. Install the device in an area that meets the protection criteria, and maintain the condition of the box as best as possible when drilling holes for the cable sheathing and/or cable clamps;
2. Avoid using multi-polar cables with conductors connected to inductive and power loads and signal conductors such as sensors and digital inputs;
3. Avoid combining power cables and signal cables in the same ducts (sensors and digital inputs)
4. Keep the connecting cables as short as possible, and do not let them coil up as coiling can subject the electronics to harmful inductive effects;
5. All the conductors used for cabling must be of sufficient size to take the required load;
6. If you need to extend the sensors, use conductors of suitable size and certainly no less than 1 mm². Extending or shortening the sensors could affect their default calibration; check and calibrate with an external thermometer.

STANDARD EQUIPMENT FOR MOUNTING AND USE

2.2

The **ECP200 EXPERT 2EV** electronic controller is provided with the following for mounting and use:

- 3 ring seals to be placed between the screw and the surface of the box;
- 1 user manual;
- 1 x NTC 10K 1% black sensor, length =1.5m
- 2 x NTC 10K 1% grey sensor, length =3m

2.3

INSTALLATION OF THE BOARD

Fig. 1: Lift the transparent protective cover on the differential thermal magnetic circuit breaker and remove the cover on the screws on the right-hand side.



Fig. 2: Undo the 4 screw fasteners on the front of the box.



Fig. 3: Close the transparent cover on the differential thermal magnetic circuit breaker.



Fig. 4: Open the front of the box, lifting it and moving the two hinges to the end of their stroke.



Fig. 5: Apply pressure on the sides of each hinge to release and fully remove the front.

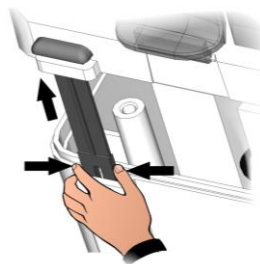

Fig. 6: Attach the box to the wall at the point of the three holes, using screws the length of which is suited to the thickness of the wall behind. Insert a rubber washer (provided) between each screw and the back of the box.

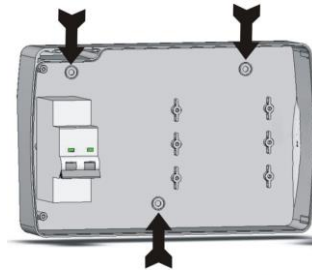
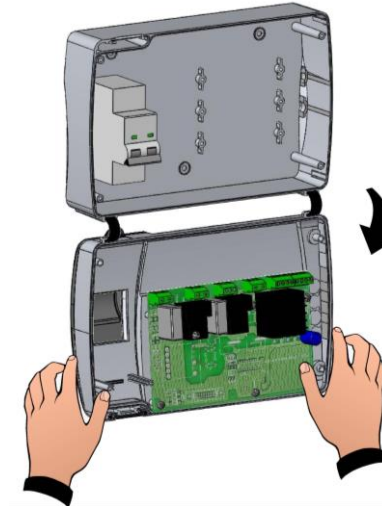

Fig. 7: Attach the front of the box back in place, re-inserting the hinges in their holes. Engage the hinges by moving the front 180° downwards to reveal the circuit board.



Make all the electrical connections with reference to the annexed diagrams for the respective model (see the tables in the ANNEXES). You are advised to use suitable cable sheathing and/or clamps to fully seal all the cables and ensure reliable connections and the degree of protection of the box. You are advised to arrange the conductors in the box as neatly as possible, keeping the power conductors separate from the signal conductors. Use clips if necessary.



Fig. 8: Close the front cover, making sure all the cables are safely fitted inside the box and the seal of the box is correctly in place. Fasten on the front cover with the 4 screws, re-using the o-rings on the neck of each screw. Turn on the board and carefully check and program all the settings.



Make sure not to fasten the screws too tightly as to do so could damage the box and affect correct operation and tactile nature of the keypad. Install devices on all power lines connected to the EPC200 electronic controller to protect the latter against overcurrent due to short-circuiting, which can damage the device. Always unplug the board and disconnect it from any inductive and power loads before executing any repairs and/or maintenance, in the interest of the operator's maximum safety.



CHAPTER 3: TECHNICAL CHARACTERISTICS

3.1

TECHNICAL CHARACTERISTICS

Power supply			
Voltage	230 V~ ± 10% 50Hz / 60Hz		
Max power consumption (electronic control only)	~ 7 VA		
Max permitted consumption (with all loads connected)	16A		
Environmental conditions			
Working temperature	-5 to +50°C		
Storage temperature	-10 to +70°C		
Relative ambient humidity	Less than 90% Hr		
General characteristics			
Type of sensor connected	NTC 10K 1%		
Resolution	0.1 °C.		
Precision of sensor readings	± 0.5 °C		
Reading range	-45 to +45 °C		
Output characteristics (outputs with clean contacts)			
Description	Relay installed	Board output characteristics	Notes
Compressor	(30A AC1 Relay)	10A 250V~ (AC3) (2HP) (100000 cycles)	The total consumption of all the following utilities must not exceed 16A and the utilities power supply must derive from downstream of the thermal magnetic circuit breaker.
Defrost 1	(16A AC1 Relay)	16A 250V~ (AC1)	
Defrost 2	(16A AC1 Relay)	16A 250V~ (AC1)	
Fans	(16A AC1 Relay)	2.7A 250V~ (AC3)	
Room light	(16A AC1 Relay)	16A 250V~ (AC1)	
Alarm / Aux (contact not live)	(8A AC1 Relay)	8(3)A 250V~	
General electrical protection		16A differential thermal magnetic circuit breaker, Id=300mA 4.5 kA breaking capacity	
Dimensional characteristics			
Dimensions	16.8cm x 9.7cm x 26.2cm (HxWxL)		
Insulation and mechanical characteristics			
Degree of protection for the box	IP65		
Material of the box	ABS self-extinguishing		
Type of insulation	Class II		

TERMS OF THE WARRANTY

4.1

The ECP200 EXPERT 2EV electronic controls are guaranteed against manufacturing defects for 24 months from the date given in the product identification code or the date on the product registration card, if available.

In the event of a defect, the equipment must be returned, in suitable packaging, to our plant or authorized assistance centre after requesting the number for authorization to return the product.

The Customer has the right to repair the defective equipment with his own manual labour and spare parts. The Customer assumes the risks for transport and covers the expenses.

The warranty does not cover:

- Damage due to tampering, negligence, lack of skill or unsuitable installation of the appliance.
- Installation, use or maintenance not in conformity with the information and instructions provided with the appliance.
- Repairs executed by unauthorized workers.
- Damage due to unforeseen events such as lightning, natural disasters, etc. In all these cases the customer covers the entire cost of repairs.

Our company may refuse to service the appliance under the warranty if it has been modified or converted without our knowledge.

Under no circumstances can PEGO S.r.l. be held responsible for any loss of data and information, the cost of replacement goods or services, damage to objects and harm to people or animals, loss of sales or earnings, downtime, any direct, indirect or accidental damage, loss of assets, insurances, fines, or any other special or associated costs, whether contractual, non-contractual or due to negligence or other responsibilities relating to use of the product or its installation.

Poor operation due to tampering, collisions, and unsuitable installation shall forfeit the warranty immediately. It is obligatory to comply with all the instructions in this manual and the conditions of use of the appliance.

PEGO S.r.l. assumes no liability for any possible inaccuracies in this manual due to printing or transcription errors.

PEGO S.r.l. reserves the right to make any changes to its products that it deems necessary or useful, without however compromising its products' essential characteristics.

Each new release of the manuals for PEGO products replaces all the previous ones.

Unless stated otherwise, the warranty is in accordance with the laws in force and, in particular, article 1512 C.C.

Disputes are settled at the court of Rovigo.

CHAPTER 5: DATA PROGRAMMING



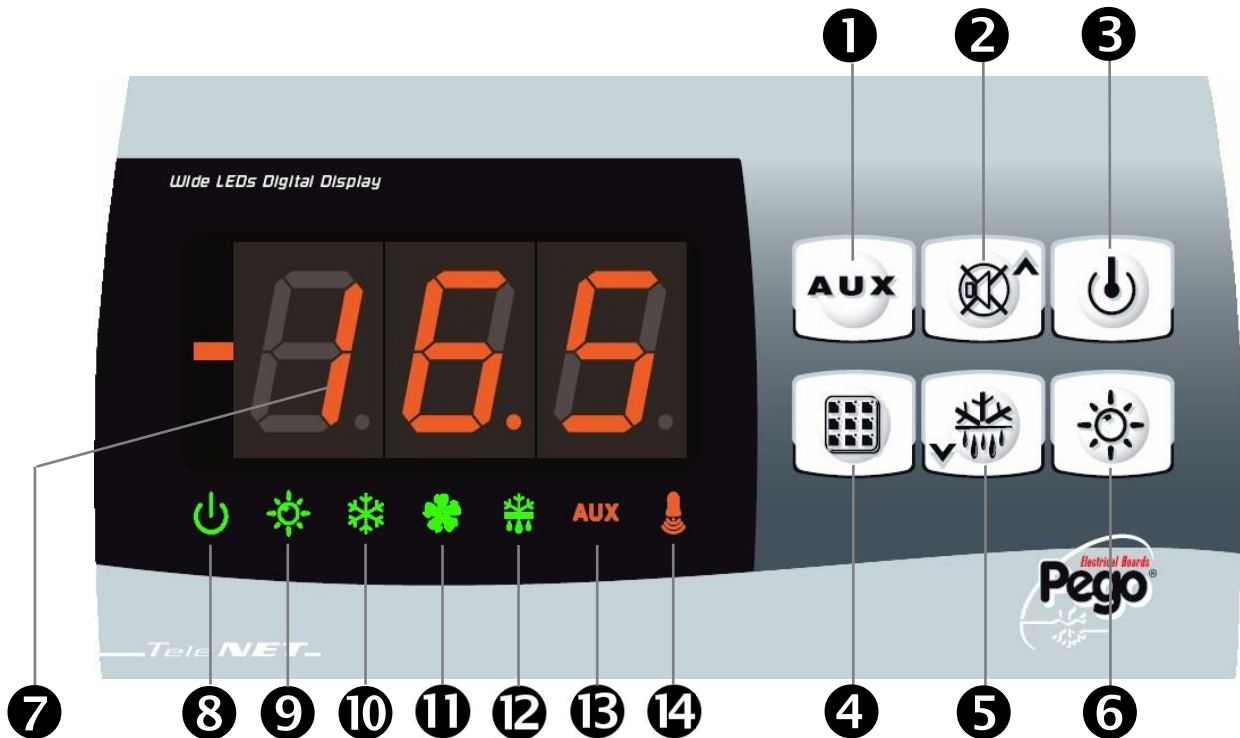

5.1



THE CONTROL PANEL



5.2

THE FRONT KEYPAD







- 1**  **AUXILIARY RELAY CONTROL**
The version with alarm relay allows you to control the relay manually if AU=1; press the button for 2.5 sec to display the current date/time.
- 2**  **UP / MUTE BUZZER ALARM**
Press for 2.5 sec to open the HACCP menu.
- 3**  **STANDBY**
Press this to stop the system. The standby light flashes.
- 4**  **SET AMBIENT TEMPERATURE**
Press for 2.5 sec together with the mute button, when on the HACCP menu, to reset the registered HACCP alarms.

- 5  DOWN / MANUAL DEFROST (press for 2.5 seconds to Start – Stop MANUAL DEFROST)
- 6  ROOM LIGHT

LED DISPLAY

5.3

7 Ambient temperature value / settings

- 8  **STANDBY ICON**
 Led OFF = Board OFF
 Led ON = Board ON and live
 Led flashing = Board in stand-by (cold outlet, defrost, fans disabled)
- 9  **DOOR SWITCH / ROOM LIGHT ICON**
 Led OFF = Door switch disabled or not in use and room light OFF
 Led ON = Room light ON
 Led Flashing = Door switch enabled and room light ON
- 10  **COLD CALL ICON**
 Led OFF = Cold call OFF
 Led ON = Cold call ON
 Led Flashing = Cold call ON but awaiting pause time C1
- 11  **FAN CALL ICON**
 Led OFF = Fan call OFF
 Led ON = Fan call ON
 Led Flashing = Fans paused after defrost (see parameter F5)
- 12  **DEFROST CALL ICON**
 Led OFF = Defrost call OFF
 Led ON = Defrost call ON
 Led Flashing = Dripping phase in progress after defrost (see parameter D7)
- 13 **AUX**  **AUXILIARY RELAY ICON** (with parameter AU=1)
 Led OFF = Aux relay call OFF
 Led ON = Aux relay call ON
- 14  **ALARM ICON**
 Led OFF = No alarm in progress
 Led ON = Alarm activated then stopped (HACCP alarm registered)
 Led Flashing = Alarm in progress

5.4

GENERAL



In the interest of safety and practicality, the **ECP200 EXPERT 2EV system** features two programming levels; the first is simply for configuring the **SETPOINT** parameters that are modified frequently, while the second is for programming and configuring the main parameters associated with the board's various work modes.

You have to exit level 1 programming before you can access the second level (you cannot go direct from level 1 to level 2).

5.5

SYMBOLS

We shall use these symbols in the interest of practicality:

- (▲) the UP button  for increasing values and silencing the alarm;
- (▼) the DOWN button  for decreasing values and starting the defrost process.

5.6

CONFIGURING AND READING THE SET POINT

1. Press the **SET button** to display the current **SETPOINT** value (temperature)
2. Hold down the **SET button** and press the (▲) or (▼) button to change the **SETPOINT** value.

Release the **SET button** to return to the room temperature. Your changes are saved automatically.

LEVEL ONE PROGRAMMING (User level)

5.7

To access the level one configuration menu:

1. Press and hold both the (▲) and (▼) buttons for a few seconds until the first programming variable appears on the display.
2. Release the (▲) and (▼) buttons.
3. Use the (▲) or (▼) button to select the variable you wish to edit.
4. After selecting the required variable you can:
 - Display its setting by pressing the SET button
 - Edit its setting by pressing and holding the SET button and pressing the (▲) or (▼) button.

After configuring the values, exit the menu by pressing and holding the (▲) and (▼) buttons for a few seconds until the room temperature value appears.

5. The changes made to the variables are saved automatically when you exit the configuration menu.

LIST OF LEVEL 1 VARIABLES (User level)

5.8

VARIABLES	MEANING	VALUES	DEFAULT
r0	Temperature differential in relation to the main SETPOINT.	0.2 - 10.0 °C	2°C
d0	Defrost interval (hours). In the case of two evaporators, the defrost process starts up at the same time for both (to delay the defrost process for evaporator 2, see variable dd2) and time d0 is loaded at the end of the previous defrost process. When d0=0 and dFr=0 Defrost disabled	0 - 24 hours	4 hours
dd2	Delayed defrost for the second evaporator (sec). The defrost process of the second evaporator starts up after the defrost process of the first evaporator. The delay between the two defrost processes is configured in dd2. Setting dd2 is to run the two defrost processes in succession. This avoids overloading the electrical system during the defrost process in the event of limited power. When dd2=0, defrost processes 1 and 2 start simultaneously.	0 - 10 sec 0 = defrost processes 1 and 2 start at the same time	0 sec
d21	Defrost end setpoint for evaporator 1. Defrost is not executed if the temperature detected by the defrost sensor is higher than the d21 value (defrost is timed if the sensor is broken).	-35 - 45 °C	15°C
d22	Defrost end setpoint for evaporator 2. Defrost is not executed if the temperature detected by the defrost sensor is higher than the d22 value (defrost is timed if the sensor is broken).	-35 - 45 °C	15°C
d31	Max defrost time for evaporator 1 (minutes)	1 - 240 min	25 min
d32	Max defrost time for evaporator 2 (minutes)	1 - 240 min	25 min
d7	Dripping time (minutes) At the end of the defrost process, the compressor and the fans stop for the d7 time configured and the defrost light on the front of the board flashes.	0 - 10 min	0 min
F5	Pause time for fans after defrost (minutes) To pause the fans for a period of time F5 after the dripping phase. This time counts down from the end of the dripping phase. If the dripping phase is not set, the fans are paused directly after the defrost process. The fan icon flashes during the pause time.	0 - 10 min	0 min

VARIABLES	MEANING	VALUES	DEFAULT
A1	<p>Minimum temperature alarm Absolute temperature for the ambient sensor below which, after the AId delay time, the EL low temperature alarm is activated and a record is made of this in the HACCP menu. When the EL alarm is activated, EL alternates with the temperature on the display, and the alarm relay, buzzer (which can be turned off), and alarm buzzer icon are all activated. The alarm turns off automatically when the conditions return to normal. The alarm light stays on to indicate the alarm has occurred and the event has been registered (see the HACCP menu to view and reset the temperature alarm concerned).</p>	-45 - A2 °C	-45°C
A2	<p>Maximum temperature alarm Absolute temperature for the ambient sensor above which, after the AId delay time, the EH high temperature alarm is activated and a record is made of this in the HACCP menu. When the EH alarm is activated, EH alternates with the temperature on the display, and the alarm relay, buzzer (which can be turned off) and alarm buzzer icon are all activated. The alarm turns off automatically when the conditions return to normal. The alarm light stays on to indicate the alarm has occurred and the event has been registered (see the HACCP menu to view and reset the temperature alarm concerned).</p>	A1 - +45 °C	+45°C
tE1	Shows the temperature detected by the sensor of evaporator 1	Shows the temperature of the evaporator (or remains blank, if dE1 =1)	Read-only
tE2	Shows the temperature detected by the sensor of evaporator 2	Shows the temperature of the evaporator (or remains blank, if dE2 =1)	Read-only
dFr	<p>Enable evaporator defrost processes in real time When d0=0 and dFr=1, it is possible to configure up to 6 defrost processes in real time within a single day, using the parameters d41...d46</p>	0 disabled 1 enabled	0
d41...d46	<p>Program timers for evaporator defrost processes It is possible to configure up to 6 timers for the defrost processes. The defrost process, or processes in the case of 2 evaporators, depends on the configuration of the variables dd2, d21, d22, d31, d32. The timer is in the HH.MM format, where HH is the hour and M the minutes in sets of ten (e.g. 0=0 min, 1=10 min, etc.). The flashing full stop (.) indicates this is a timer and not a temperature.</p>	00.0 - 23.5	--

LEVEL TWO PROGRAMMING (Installer level)

5.9

To access level two configuration, press and hold the UP (▲), DOWN (▼) and LIGHT buttons for a few seconds.

The system automatically goes into standby when the first programming variable appears.

1. Use the (▲) or (▼) button to select the variable you wish to edit. After selecting the required variable you can:
2. Display its setting by pressing the SET button
3. Edit its setting by pressing and holding the SET button and pressing the (▲) or (▼) button.
4. After configuring the values, exit the menu by pressing and holding the (▲) and (▼) buttons for a few seconds until the room temperature value appears.
5. The changes made to the variables are saved automatically when you exit the configuration menu.
6. Press the STANDBY button to enable the electronic control.

LIST OF LEVEL 2 VARIABLES (Installer level)

5.10

VARIABLES	MEANING	VALUES	DEFAULT
nrE	Number of evaporators Configuring nrE=1 disables evaporator 2 and the defrost 2 output becomes a clean contact for calling the motor condensing unit (output parallel with compressor call). Output with clean contact.	1 = 1 evaporator 2 = 2 evaporators	2
AC	Status of the door switch input	0 = Normally open 1 = Normally closed	0
F3	Status of the fans with compressor OFF	0 = Fans run continuously 1 = Fans run only when compressor is ON	1
F4	Fan standby time during defrost	0 = The fans run during the defrost process 1 = The fans do not run during the defrost process	1
dE1	Presence of sensor for evaporator 1 When the evaporator sensor is disabled, the defrosting processes run cyclically for the time d0 or according to the real time clock, and end when the time d31 elapses.	0 = sensor of evaporator 1 present 1 = sensor of evaporator 1 absent	0
dE2	Presence of sensor for evaporator 2 When the evaporator sensor is disabled, the defrosting processes run cyclically for the time d0 or according to the real time clock, and end when the time d32 elapses.	0 = sensor of evaporator 2 present 1 = sensor of evaporator 2 absent	0
dC	Status of input for 'man in room' alarm	0 = NO 1 = NC	0
d1	Type of defrost , with cycle inversion (hot gas) or elements.	1 = hot gas 0 = elements	0

Ad	Network address for connection to the <i>TeleNET</i> supervision system	0 - 31	0
AId	Delay time for signalling and displaying the minimum or maximum temperature alarm .	1...240 min	120 min
C1	Minimum time between the shutdown and next start-up of the compressor	0...15 min	0 min
CE1	Compressor run time in event of broken ambient sensor (emergency operation) With CE1=0, emergency operation in the event of the E0 error is disabled: the compressor remains switched off and the defrost processes are disabled to preserve the residual cold.	0...240 min 0= disabled	0 min
CE2	Compressor run time OFF in event of broken ambient sensor (emergency operation)	5...240 min	5 min
CAL	Correction of the ambient sensor reading	-10...+10	0
Pc	Status of compressor protection contact	0 = NO 1 = NC	0
doC	Run time of compressor for door switch , when the door switch opens the evaporator fans turn off and the compressor continues to run for the time doC before turning off.	0...5 minutes	0
tdo	Time for re-activating the compressor after opening of door . Normal operation of the control is restored when the door switch opens and after the tdo time has elapsed, and the door open alarm is activated (Ed). With tdo=0, the parameter is disabled.	0...240 min 0 = disabled	0
Fst	FAN disabling TEMPERATURE The fans remain at standstill if the temperature detected by the evaporator sensor is higher than the value of this parameter.	-45...+45°C	+45°C
Fd	Differential for Fst	1...+10°C	2°C
tA	Switching of status for NO – NC alarm relay	0=energizes in event of alarm 1=de-energizes in event of alarm	1
LSE	Minimum value of the setpoint	-45 - HSE °C	-45°C
HSE	Maximum value of the setpoint	+45 - HSE °C	+45°C
AU	Management of the RL6 configurable relay	0= alarm relay 1= manual auxiliary relay commanded by the AUX button 2= automatic auxiliary relay controlled by the StA temperature set with 2°C differential 3= pump down function 4= clean contact for calling the motor condensing unit (AUX relay parallel to the compressor) 5 = Contact for controlling the guard element (AUX relay closed with compressor output not enabled).	0
StA	Temperature set points for auxiliary relay	-45...+45°C	0

P1	Password: for protection (enabled when PA is set at a number other than 0)	0 = displays only the set point 1 = displays the set point, access to the light and AUX buttons 2 = prevents access to programming 3 = prevents access to level two programming	3
PA	Password (see P1 for type of protection)	0...999 0 = function disabled	0
Yr	Year configuration	0...99	-
Mo	Month configuration	1...12	-
dy	Day configuration	1...31	-
Hr	Hour configuration	0...23	-
min	Minute configuration	0...59	-
reL	Software release	The software version	Read-only

5.11

HACCP ALARM MANAGEMENT

The EL low temperature alarm is activated at the end of the Ald time when the ambient sensor temperature is $\leq A1$.

The EH high temperature alarm is activated at the end of the Ald time when the ambient sensor temperature is $\geq A2$.

During a high or low temperature alarm, the temperature alternates with EH or EL on the display; and the alarm relay, buzzer (which can be silenced) and alarm buzzer icon (flashing) are activated.

The alarm signals stop automatically when normal operation is restored (the alarm relay is deactivated, the buzzer stops and the display returns to normal).

The alarm buzzer icon, however, remains on (steady) to indicate the EH or EL alarm has been activated and that the event has been registered (see the HACCP menu to view and reset the temperature alarm that has occurred).

An alarm log states the date the last EH or EL event occurred, its duration and the maximum or minimum temperature reached.

There is also a counter that indicates the number of alarms to have occurred since the last alarm reset.

To view a temperature alarm, access the HACCP menu (press the mute button for 2.5 seconds).

It is possible to reset the alarm registered in the menu by pressing and holding the mute and SET buttons for 2.5 seconds.

The buzzer beeps to confirm the alarm is cancelled.

To exit the menu, wait for 10 seconds without touching any of the buttons, or press the up and down arrow buttons at the same time.

The variables in the HACCP menu are read-only and are as follows:

VARIABLES	MEANING	VALUES	DEFAULT
E##	Indicates the last temperature alarm to have occurred	EH = high temperature alarm EL = low temperature alarm -- = no alarm occurred since last reset	Read only
###	Peak temperature value reached during last EH or EL alarm	-45...+45°C --- = no alarm occurred since last reset	Read only
y##	Year the last temperature alarm started	y00 – y99 y-- = no alarm occurred since last reset	Read only
M##	Month the last temperature alarm started	M01 – M12 M-- = no alarm occurred since last reset	Read only
d##	Day the last temperature alarm started	d01 – d31 d-- = no alarm occurred since last reset	Read only
h##	Hour the last temperature alarm started	h00 – h24 h-- = no alarm occurred since last reset	Read only
m##	Minutes the last temperature alarm started	m00 – m59 m-- = no alarm occurred since last reset	Read only
t##	Time (hours) the last temperature alarm lasted	t00 – t99 t-- = no alarm occurred since last reset	Read only
C##	Counter indicating the number of temperature alarm events occurred (when the data is registered for an alarm event, the reading on the counter increases by one and the counter indicates whether other alarms occurred previously. The counter is reset at the same time as resetting the registered alarm (press the mute and SET button x 5sec.) The counter increases by one whenever a new temperature alarm occurs).	C00 – C99 C-- = no alarm occurred since last reset	Read only

STARTING UP THE ECP200 EXPERT 2EV ELECTRONIC CONTROLLER**5.12**

After fully connecting the electronic controller, turn on the 230 Vac power supply; immediately, the electrical board emits a sound for a few seconds and all the LEDs on the display switch on.

CONFIGURATIONS**5.13**

- Use of 1 evaporator
- Use of 2 evaporators

Configure the nrE (number of evaporators) parameter to select one of these options.

When nrE=1, the sensor of evaporator 2 is disabled, variables d22 and d32 are ignored, variable tE2 is displayed as ---, and the defrost 2 output becomes a clean contact for calling the motor condensing unit (output parallel with compressor call)

In the event of defrosting with 2 evaporators, normal thermostatisation does not occur until the defrosting processes for both evaporators have ended.

CONDITIONS FOR ENABLING / DISABLING THE COMPRESSOR**5.14**

The **ECP200 EXPERT 2EV** controller activates the compressor command when the ambient temperature exceeds the sum of the configured set point and the differential (r0); and deactivates the compressor when the ambient temperature is less than the configured set point.

If you decide to select the Pump-Down function (parameter AU=4), refer to chapter 5.15 on the conditions for activating/deactivating the compressor.

MANUAL ACTIVATION OF THE DEFROSTING PROCESS**5.15**

To start the defrosting process, simply press the  button for a few seconds; this activates the relay of the elements when the conditions are right.

The defrosting process of each of the two evaporators ends when the temperature of the associated defrost end variable (d21 or d22) is reached, or when the maximum defrost time (d31 or d32) elapses. The delay between the processes (variable dd2) is also factored in.

A defrosting output is not activated when the temperature of the respective defrost end variable (d21 or d22) is found to be less than the temperature detected by the sensor of the evaporator concerned.

Manual defrosting is also possible when the defrosting processes are configured using the real time clock.

5.16**STOPPING THE DEFROSTING PROCESS MANUALLY**

Pressing the  button for 2.5 seconds when defrosting is in progress stops both defrosting processes.

5.17**DEFROSTING WITH HOT GAS**

Set parameter d1 = 1 to select defrosting with cycle inversion.

The compressor relay and defrost relays are activated during the entire defrosting phase.

To run the plant correctly, the installer must ensure the defrost output opens the cycle inversion solenoid valve and closes the liquid solenoid valve.

For capillary plants (without thermostatic valve), simply use the cycle inversion solenoid valve with the defrost relay command.

5.18**PUMP DOWN FUNCTION**

Setting parameter AU=3 enables shutdown of the compressor in pump down mode.

The digital “main in room” alarm input becomes a work pressure gauge input and controls the compressor output directly. The AUX relay (clean contact on connectors 21 – 22) becomes the evaporator solenoid call and is controlled by the thermostat’s cold call.

THE PASSWORD FUNCTION**5.19**

The password function is activated by setting the PA parameter at a value other than 0. Refer to parameter P1 for the different levels of protection.

Protection is enabled automatically if the keypad is not used for about 2 minutes.

The digit 000 appears on the display. Use the up/down buttons to modify the number, and press the SET button to confirm.

If you forget the password, use the universal number 100.

(P.S. the password window closes to return to normal view if the keypad is not used for 30 seconds).

**EMERGENCY OPERATION IN THE EVENT OF BROKEN
AMBIENT SENSOR (E0)****5.20**

This safety mode allows the compressor to continue running even when the ambient sensor is broken (E0 error).

When there is the E0 sensor error and CE1 is set at a number other than 0, the compressor works in work pause mode, turning ON for the CE1 time and OFF for the CE2 time.

When $CE1 > 0$ and there is the E0 error, the defrost processes run in normal work mode.

When $CE1 = 0$ and there is the E0 error, emergency operation is disabled: the compressor remains off and the defrost processes are disabled to preserve any residual cold.

Eliminate the cause of the E0 error as soon as possible and re-enable normal operation of the controller for correct temperature control.

CURRENT DATE AND TIME**5.21**

When you are not programming, press the AUX button for 2.5 seconds to display the current date and time. Each of the following variables is displayed for 2 seconds in succession:

y## : (year)
M##: (month)
d##: (day)
h##: (hour)
m##: (minutes)

The temperature is displayed again at the end.

CHAPTER 6: OPTIONS

6.1

TELENET MONITORING/SUPERVISION SYSTEM

Connect the ECP200 EXPERT 2EV to the TeleNET monitoring and supervision system as follows:

1. Assign a single network address with the 2nd level Ad. variable.
2. The TeleNET connectors on the board are 10=RS-485(A) and 11=RS-485(B); respect identification (A) and (B) of the RS-485 line and do not execute star connections. Refer to the connection example shown below.
3. In the TeleNET program, when creating the new instrument, set the "Module" as "Instrument ECP 200 2EV".

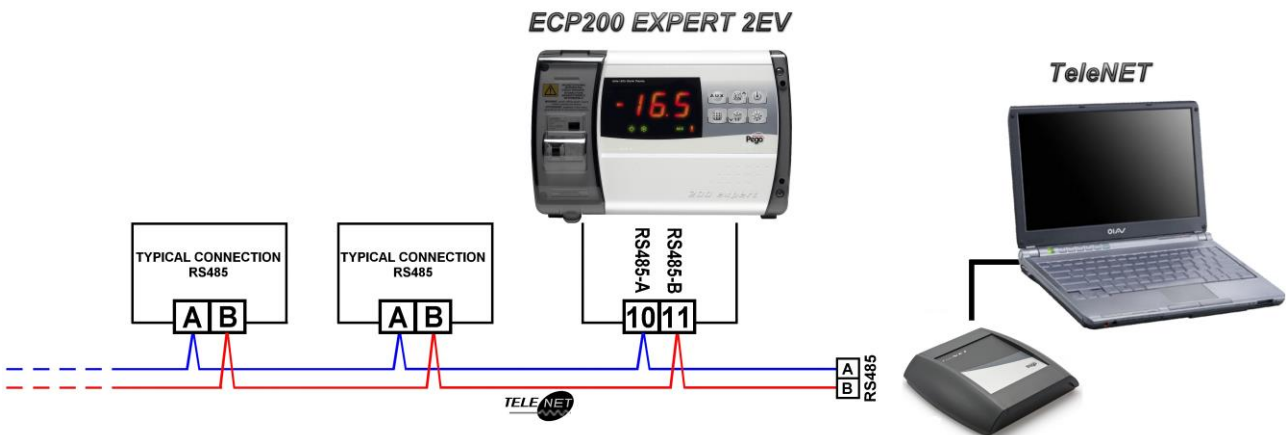

CHAPTER 7: DIAGNOSTICS

DIAGNOSTICS

7.1

The **ECP200 EXPERT 2EV** controller warns the operator of any errors by displaying alarm codes and sounding the internal buzzer. In the event of an alarm, the  icon appears on the display, the alarm relay is activated (if configured with AU=0), the internal buzzer is activated and one of the following alarm codes appears. You can press the “Mute” button at any time to stop the internal buzzer and remove the alarm code from the display. Pressing the SET button afterwards re-activates the acoustic warning and puts the codes back up on the display (the buzzer cannot be muted in the event of serious alarms).

ALARM CODE	POSSIBLE CAUSE	SOLUTION
E0	Functional fault of the ambient sensor	Check the condition of the ambient sensor. Replace the sensor if the problem persists.
E1	Functional fault of defrost sensor 1 (in this case any defrost processes last for the time set in parameter d31)	Check the condition of defrost sensor 1. Replace the sensor if the problem persists.
E2	Functional fault of defrost sensor 2 (in this case any defrost processes last for the time set in parameter d32)	Check the condition of defrost sensor 2. Replace the sensor if the problem persists.
E3	Eeprom alarm An error has occurred in the EEPROM memory. (All the outputs are disabled with the exception of the alarm ones)	Turn the appliance off and then on again
E6	Battery low alarm ; the controller will continue to work for at least another 20 days, and when the battery is completely dead the time settings are cancelled.	Replace the battery
E8	“Man in room” alarm The “man in room” button has been pressed to warn of a dangerous situation	Reset the button in the room
Ec	Activation of the compressor’s protective devices (e.g. thermal protection or max pressure gauge). (All the outputs are disabled with the exception of the alarm ones, if available)	Check the condition of the compressor Check the consumption of the compressor Contact the technical assistance service if the problem persists
Ed	Door open alarm The door has been open for longer than the configured tdo time.	Close the door. Check the condition of the door switch and its connections.
EL	Minimum temperature alarm EL flashes on the display in alternation with the temperature (see parameter A1)	
EH	Maximum temperature alarm EH flashes on the display in alternation with the temperature (see parameter A2)	

ANNEXES

A.1

CE DECLARATION OF CONFORMITY

COSTRUTTORE / MANUFACTURER:



PEGO S.r.l. Via Piacentina, 6/b 45030 Occhiobello (RO) – Italy –
Tel. (+39) 0425 762906 Fax. (+39) 0425 762905

DENOMINAZIONE DEL PRODOTTO / NAME OF THE PRODUCT:

MOD.: ECP200 EXPERT 2EV

IL PRODOTTO E' CONFORME ALLE SEGUENTI DIRETTIVE CE:

THE PRODUCT IS IN CONFORMITY WITH THE REQUIREMENTS OF THE FOLLOWING EUROPEAN DIRECTIVES:

Direttiva Bassa Tensione (LVD): **2014/35/UE**
Low voltage directive (LVD): **2014/35/EU**

Direttiva EMC: **2014/30/CE**
Electromagnetic compatibility (EMC): **2014/30/EU**

LA CONFORMITA' PRESCRITTA DALLA DIRETTIVA E' GARANTITA DALL'ADEMPIMENTO A TUTTI GLI EFFETTI DELLE SEGUENTI NORME (comprese tutte le modifiche):

THE CONFORMITY WITH THE REQUIREMENTS OF THIS DIRECTIVE IS TESTIFIED BY COMPLETE ADHERENCE TO THE FOLLOWING STANDARDS (including all amendments):

Norme armonizzate: **EN 60204-1:2006, EN 61439-1:2011, EN 61000-6-1:2007, EN 61000-6-3:2007**
European standards: **EN 60204-1:2006, EN 61439-1:2011, EN 61000-6-1:2007, EN 61000-6-3:2007**

IL PRODOTTO E' COSTITUITO PER ESSERE INCORPORATO IN UNA MACCHINA O PER ESSERE ASSEMBLATO CON ALTRI MACCHINARI PER COSTITUIRE UNA MACCHINA CONSIDERATE DALLA DIRETTIVA: 2006/42/CE "Direttiva Macchine".

THE PRODUCT HAS BEEN MANUFACTURED TO BE INCLUDED IN A MACHINE OR TO BE ASSEMBLED TOGETHER WITH OTHER MACHINERY TO COMPLETE A MACHINE ACCORDING TO DIRECTIVE: EC/2006/42 "Machinery Directive".

Occhiobello (RO), 01/04/2016

Paolo Pegorari
Rappresentante Legale

ECP200 EXPERT 2EV CONNECTION DIAGRAM

A.2

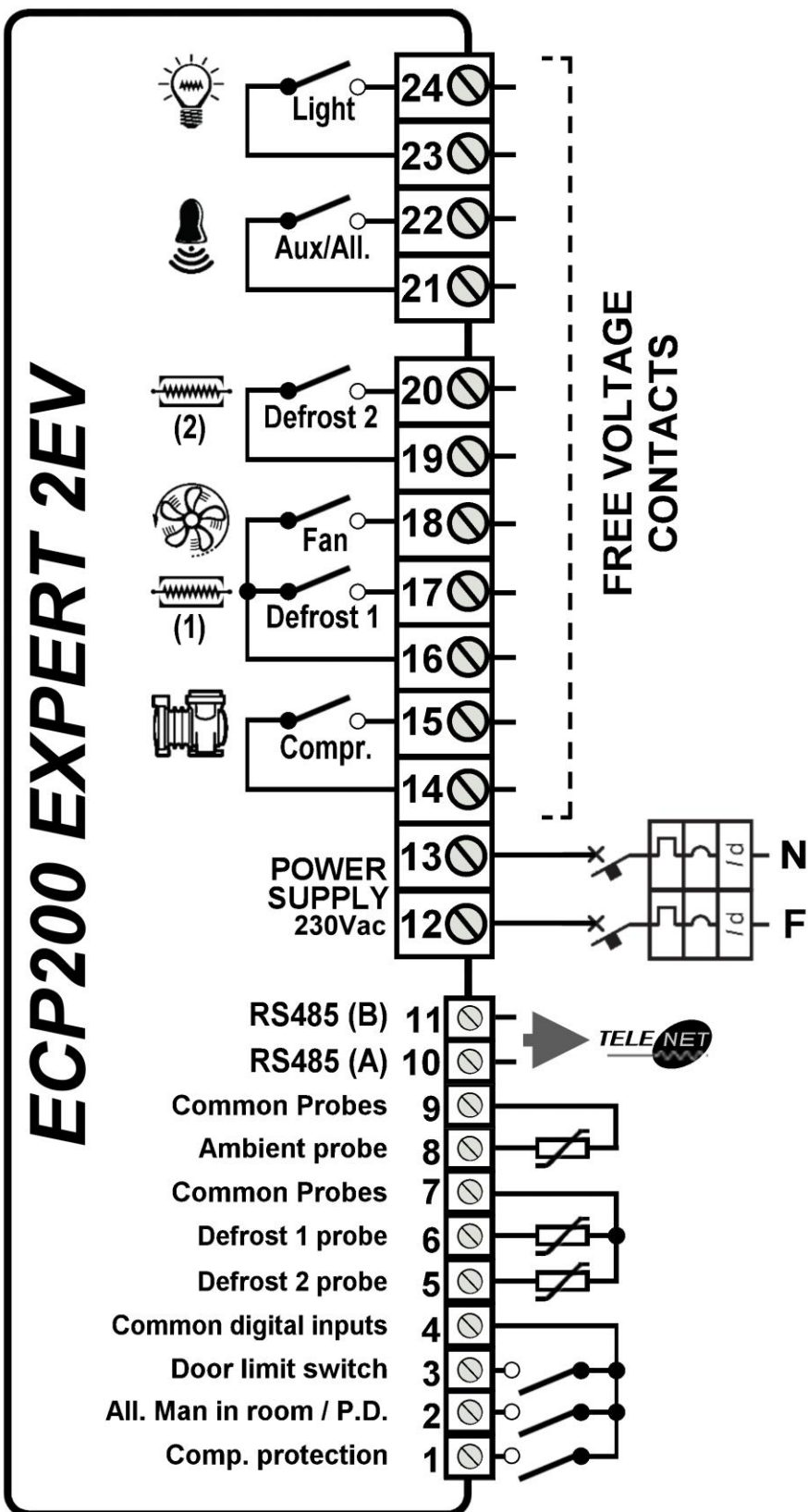

A.3

EXPLODED DIAGRAM

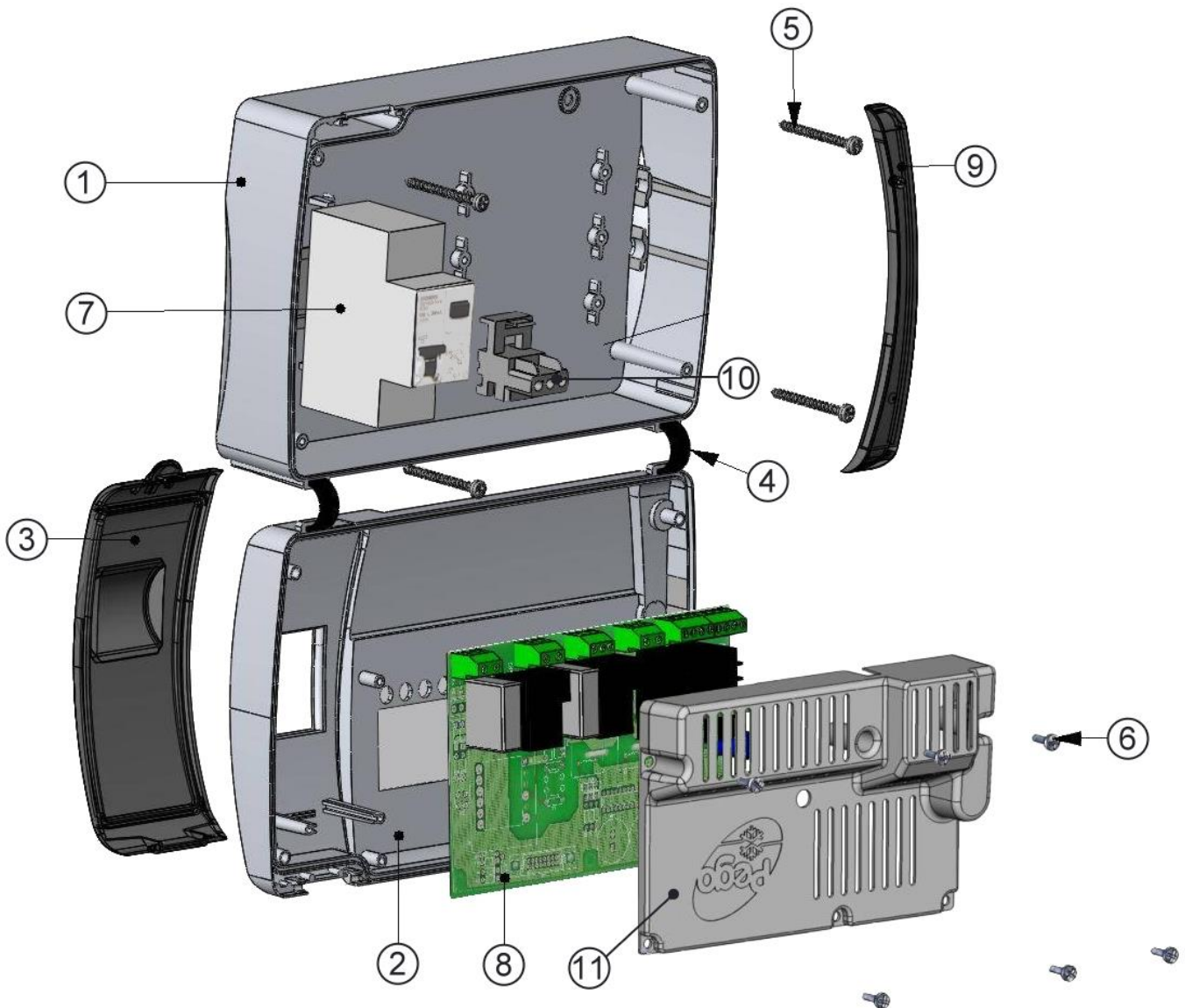

LEGEND

REF.	DESCRIPTION
1	BACK BOX IN ABS
2	FRONT BOX IN ABS
3	TRANSPARENT POLYCARBONATE COVER AT FRONT
4	HINGES FOR OPENING THE FRONT BOX
5	SCREWS FOR BOX
6	SCREWS FOR CONNECTION TO THE BOARD
7	DIFFERENTIAL THERMAL MAGNETIC PROTECTION / CIRCUIT BREAKER
8	CPU BOARD
9	POLYCARBONATE COVER FOR THE SCREWS
10	EARTH CONNECTOR
11	PROTECTIVE COVER FOR BOARD



PEGO S.r.l.

Via Piacentina, 6/b

45030 OCCHIOBELLO –ROVIGO-

Tel : 0425 762906

Fax: 0425 762905

www.pego.it

e-mail: info@pego.it

Distributor: