



Commessa

TTL300 EXPERT U VD 12

COPYING OF THIS DOCUMENT, AND GIVING IT TO OTHERS AND THE USE OR COMMUNICATION OF THE CONTENTS THEREOF, ARE FORBIDDEN WITHOUT EXPRESS AUTHORITY. OFFENDERS ARE LIABLE TO THE PAYMENT OF DAMAGES. ALL RIGHTS ARE RESERVED IN THE EVENT OF THE GRANT OF A PATENT OF THE REGISTRATION OF A UTILITY MODEL OR DESIGN

DESIGN TYPE		DEFAULT VOLTAGE	400 Vac	STANDARD	CEI 44-6	ENCLOSURE
SERIE		CONTROLS VOLTAGE	230 Vac	+ =		
ORDER CODE		SIGNALS VOLTAGE	230 Vac			
CUSTOMER		TOTALINE				
DESIGNED WITH CAD/CAE SYSTEM		Sabik 9				
		ECP300 EXPERT U VD 12				
		DATE	SIGNAT.	SCHEMA FUNZIONALE		
		COMM.	17/04/2007	TABELLE DI RIEPILOGO		
		CHECK.	17/04/2007	MORSETTIERE		
		APPROV.	17/04/2007			
					TOTALINE	
					standard panel	
REV.	REVISION DESCRIPTION	DATE	COMMISS.	SUB. FOR:	SUBST.:	ORIGIN:
						T.S. 9

PROJECT: TTL300ExpertUVD12.sch
 FILE NAME: TTL300ExpertUVD12.sch
 TYPE:

DATE 30/03/2007
 COMMISS. Bonvicini
 CHECKED BY
 APPROV.

COPYING OF THIS DOCUMENT, AND GIVING IT TO OTHERS AND THE USE OR COMMUNICATION OF THE CONTENTS THEREOF, ARE FORBIDDEN WITHOUT EXPRESS AUTHORITY. OFFENDERS ARE LIABLE TO THE PAYMENT OF DAMAGES. ALL RIGHTS ARE RESERVED IN THE EVENT OF THE GRANT OF A PATENT OF THE REGISTRATION OF A UTILITY MODEL OR DESIGN.

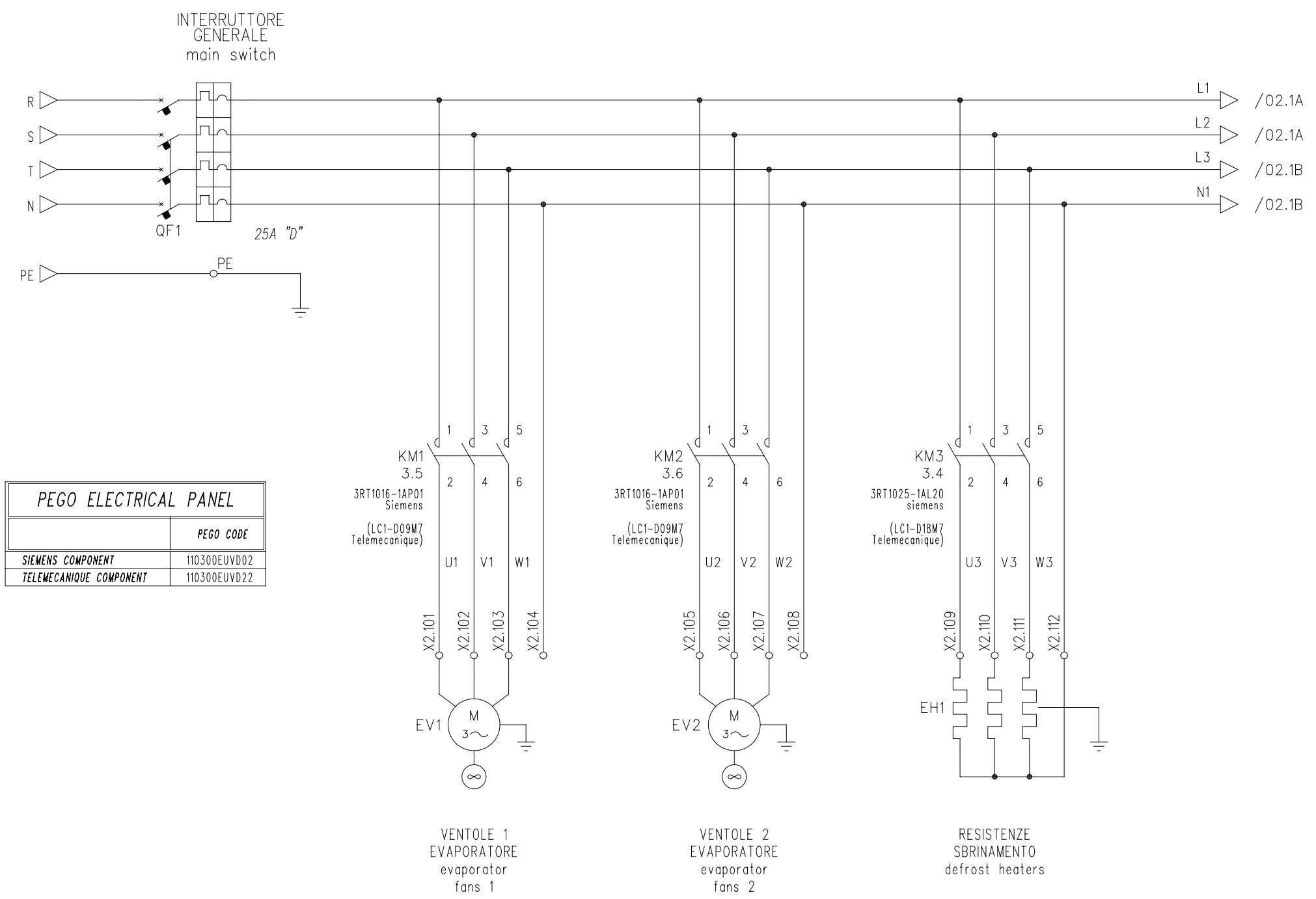

PEGO ELECTRICAL PANEL	
	PEGO CODE
SIEMENS COMPONENT	110300EUVD02
TELEMECANIQUE COMPONENT	110300EUVD22



TTL300 EXPERT U VD 12

=	TTL300 EXPERT U VD 1
+	
	SHEET 1
N.S. 2	T.F. 9

COPYING OF THIS DOCUMENT, AND GIVING IT TO OTHERS AND THE USE OR COMMUNICATION OF THE CONTENTS THEREOF, ARE FORBIDDEN WITHOUT EXPRESS AUTHORITY. OFFENDERS ARE LIABLE TO THE PAYMENT OF DAMAGES. ALL RIGHTS ARE RESERVED IN THE EVENT OF THE GRANT OF A PATENT OF THE REGISTRATION OF A UTILITY MODEL OR DESIGN.

PROJECT: TTL300ExpertUVD12.sch
 FILE NAME: TTL300ExpertUVD12.sch
 TYPE:

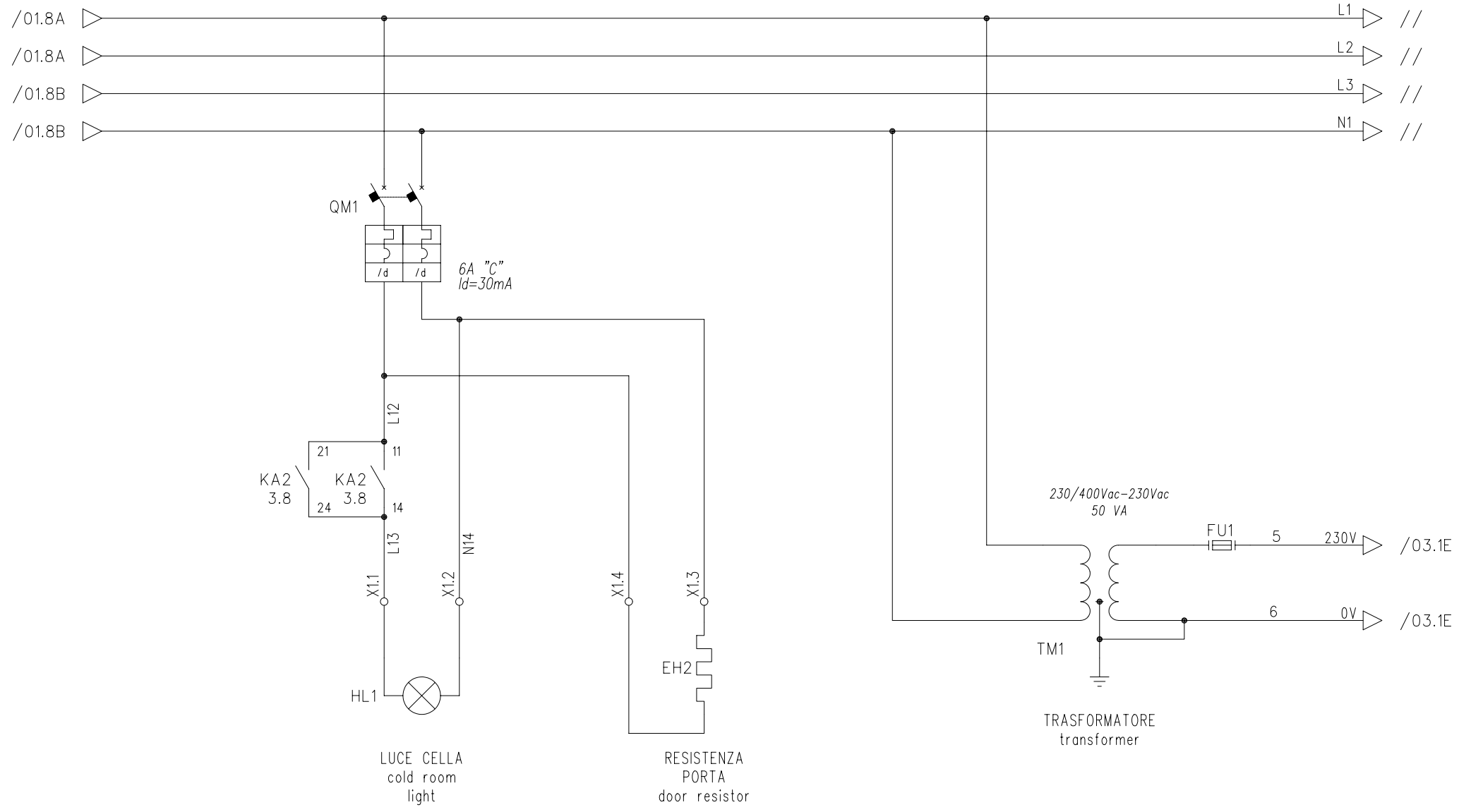

DATE	30/03/2007
COMMISS.	Bonvicini
CHECKED BY	
APPROV.	



TTL300 EXPERT U VD 12

=	TTL300 EXPERT U VD 1
+	
	SHEET 2
	N.S. 3 T.F. 9

COPYING OF THIS DOCUMENT, AND GIVING IT TO OTHERS AND THE USE OR COMMUNICATION OF THE CONTENTS THEREOF, ARE FORBIDDEN WITHOUT EXPRESS AUTHORITY. OFFENDERS ARE LIABLE TO THE PAYMENT OF DAMAGES. ALL RIGHTS ARE RESERVED IN THE EVENT OF THE GRANT OF A PATENT OF THE REGISTRATION OF A UTILITY MODEL OR DESIGN.

PROJECT: TTL300ExpertUVD12.sch
 FILE NAME: TTL300ExpertUVD12.sch
 TYPE:

DATE 30/03/2007
 COMMISS. Bonvicini
 CHECKED BY
 APPROV.

SUBST.: SUB. FOR:



TTL300 EXPERT U VD 12

= TTL300 EXPERT U VD 1
 +
 SHEET 3
 N.S. 4 T.F. 9

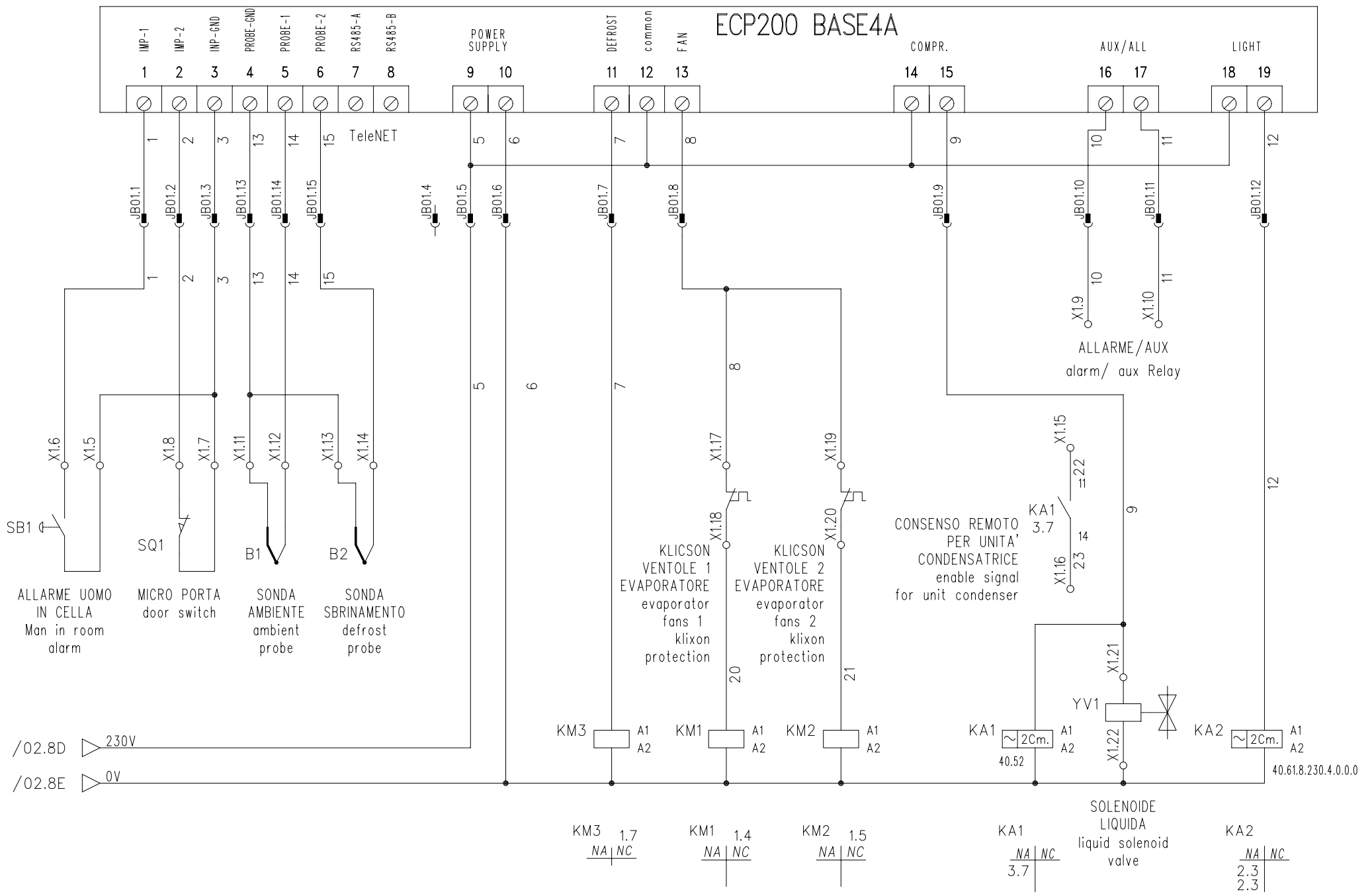

RIEPILOGO CONNETTORI

connectors summary

JB01

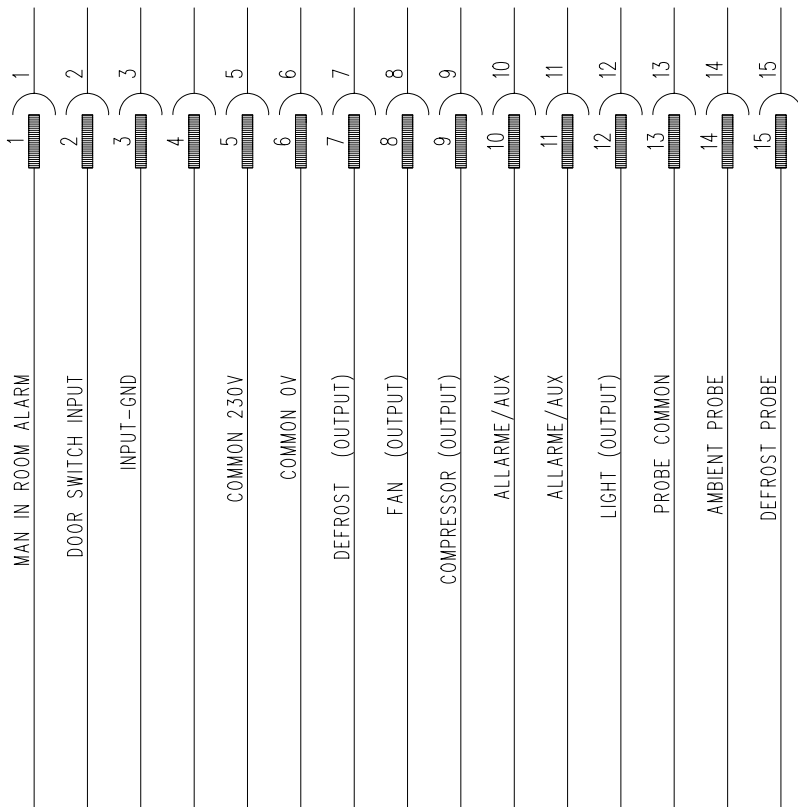

COPYING OF THIS DOCUMENT, AND GIVING IT TO OTHERS AND THE USE OR COMMUNICATION OF THE CONTENTS THEREOF, ARE FORBIDDEN WITHOUT EXPRESS AUTHORITY. OFFENDERS ARE LIABLE TO THE PAYMENT OF DAMAGES. ALL RIGHTS ARE RESERVED IN THE EVENT OF THE GRANT OF A PATENT OF THE REGISTRATION OF A UTILITY MODEL OR DESIGN.

PROJECT: TTL300ExpertUVD12.sch
 FILE NAME: TTL300ExpertUVD12.sch
 TYPE:

DATE	30/03/2007
COMMISS.	Bonvicini
CHECKED BY	
APPROV.	

RIEPILOGO CONNETTORI



TTL300 EXPERT U VD 12

=	TTL300 EXPERT U VD 12
+	
	SHEET 4
N.S. 5	T.F. 9

COPYING OF THIS DOCUMENT, AND GIVING IT TO OTHERS AND THE USE OR COMMUNICATION OF THE CONTENTS THEREOF, ARE FORBIDDEN WITHOUT EXPRESS AUTHORITY. OFFENDERS ARE LIABLE TO THE PAYMENT OF DAMAGES. ALL RIGHTS ARE RESERVED IN THE EVENT OF THE GRANT OF A PATENT OF THE REGISTRATION OF A UTILITY MODEL OR DESIGN.

PROJECT: TTL300ExpertUVD12.sch
FILE NAME:
TYPE:

DATE: 30/03/2007
COMMISS.: Bonvicini
CHECKED BY:
APPROV.:

RIEPILOGO MORSETTI
TERMINAL BOARD SUMMARY



TTL300 EXPERT U VD 12

= TTL300 EXPERT U VD 1
+
SHEET 5
N.S. 6 T.F. 9

X1

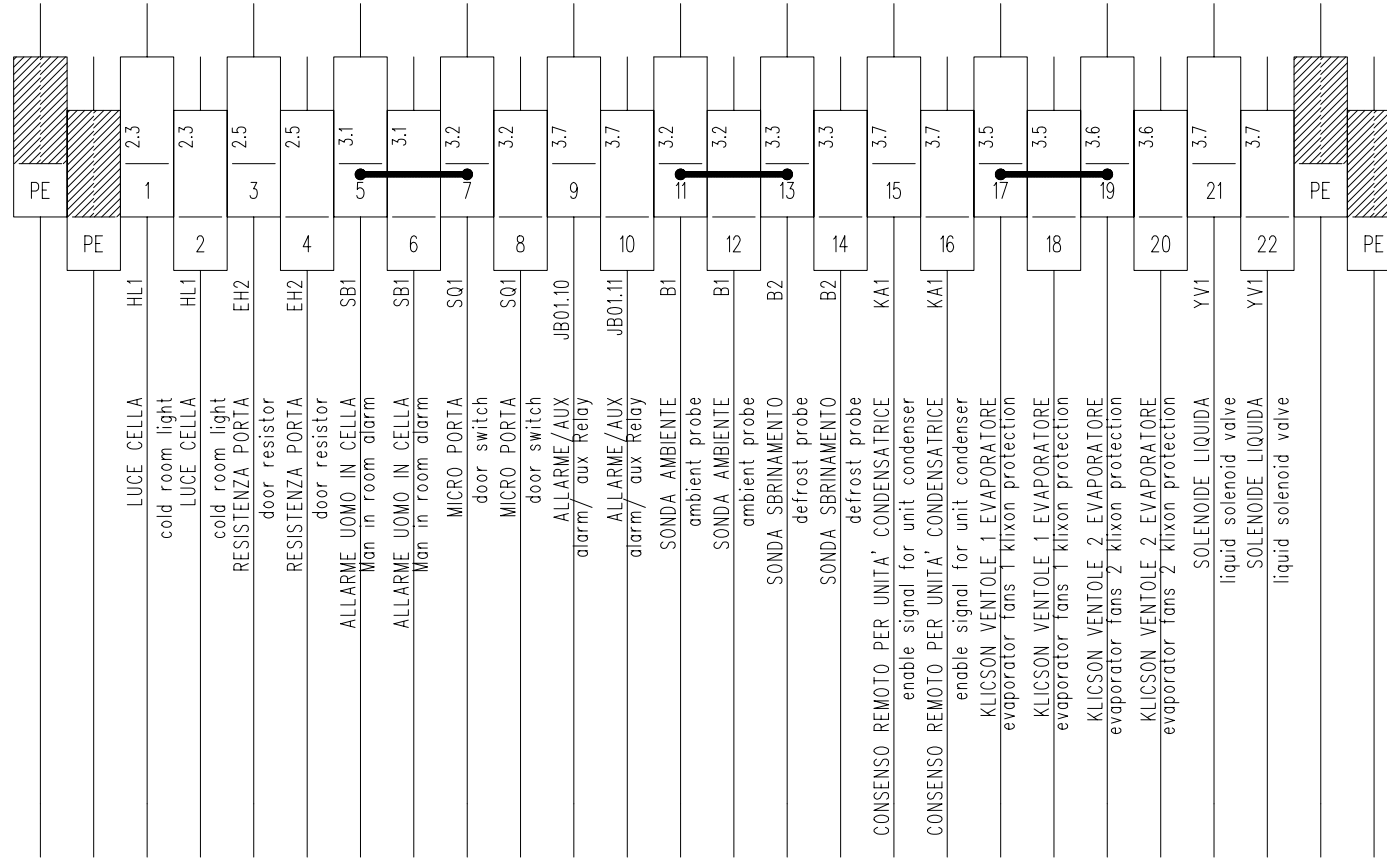

- PONTE bridge
- PIANO SUPERIORE MORSETTIERA high level terminal block
- PIANO INFERIORE MORSETTIERA low level terminal block

MORSETTI DOPPI
double terminal block

COPYING OF THIS DOCUMENT, AND GIVING IT TO OTHERS AND THE USE OR COMMUNICATION OF THE CONTENTS THEREOF, ARE FORBIDDEN WITHOUT EXPRESS AUTHORITY. OFFENDERS ARE LIABLE TO THE PAYMENT OF DAMAGES. ALL RIGHTS ARE RESERVED IN THE EVENT OF THE GRANT OF A PATENT OF THE REGISTRATION OF A UTILITY MODEL OR DESIGN.

PROJECT: TTL300ExpertUVD12.sch
 FILE NAME: TTL300ExpertUVD12.sch
 TYPE:

X2

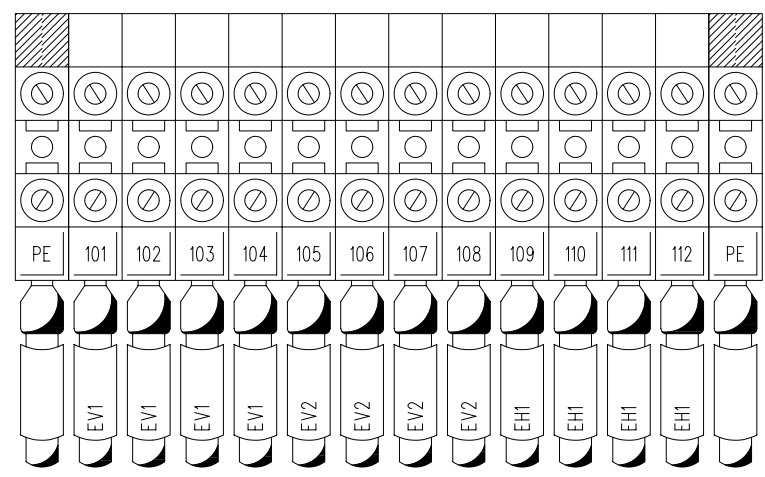

VENTOLE 1 EVAPORATORE
 evaporator fans 1
 VENTOLE 1 EVAPORATORE
 evaporator fans 1
 VENTOLE 1 EVAPORATORE
 evaporator fans 1
 NEUTRO PER VENTOLE 1 EVAPORATORE
 neutral connection for evaporator fans 1
 VENTOLE 2 EVAPORATORE
 evaporator fans 2
 VENTOLE 2 EVAPORATORE
 evaporator fans 2
 VENTOLE 2 EVAPORATORE
 evaporator fans 2
 NEUTRO PER VENTOLE 2 EVAPORATORE
 neutral connection for evaporator fans 2
 RESISTENZE SBRINAMENTO
 defrost heaters
 RESISTENZE SBRINAMENTO
 defrost heaters
 RESISTENZE SBRINAMENTO
 defrost heaters
 NEUTRO PER RESISTENZE DI SBRINAMENTO
 neutral connection for .defrost heaters

DATE 30/03/2007
 COMMISS. Bonvicini
 CHECKED BY
 APPROV.

RIEPILOGO MORSETTI
 TERMINAL BOARD SUMMARY



TTL300 EXPERT U VD 12

= TTL300 EXPERT U VD 1
 +
 SHEET 6
 N.S. 7 T.F. 9

PROJECT: TTL300ExpertUVD12.sch
 FILE NAME: TTL300ExpertUVD12.sch
 TYPE:

DATE 30/03/2007
 COMMISS. Bonvicini
 CHECKED BY
 APPROV.

LAY OUT



TTL300 EXPERT U VD 12

= TTL300 EXPERT U VD 1
 +
 SHEET 7
 N.S. 8 T.F. 9

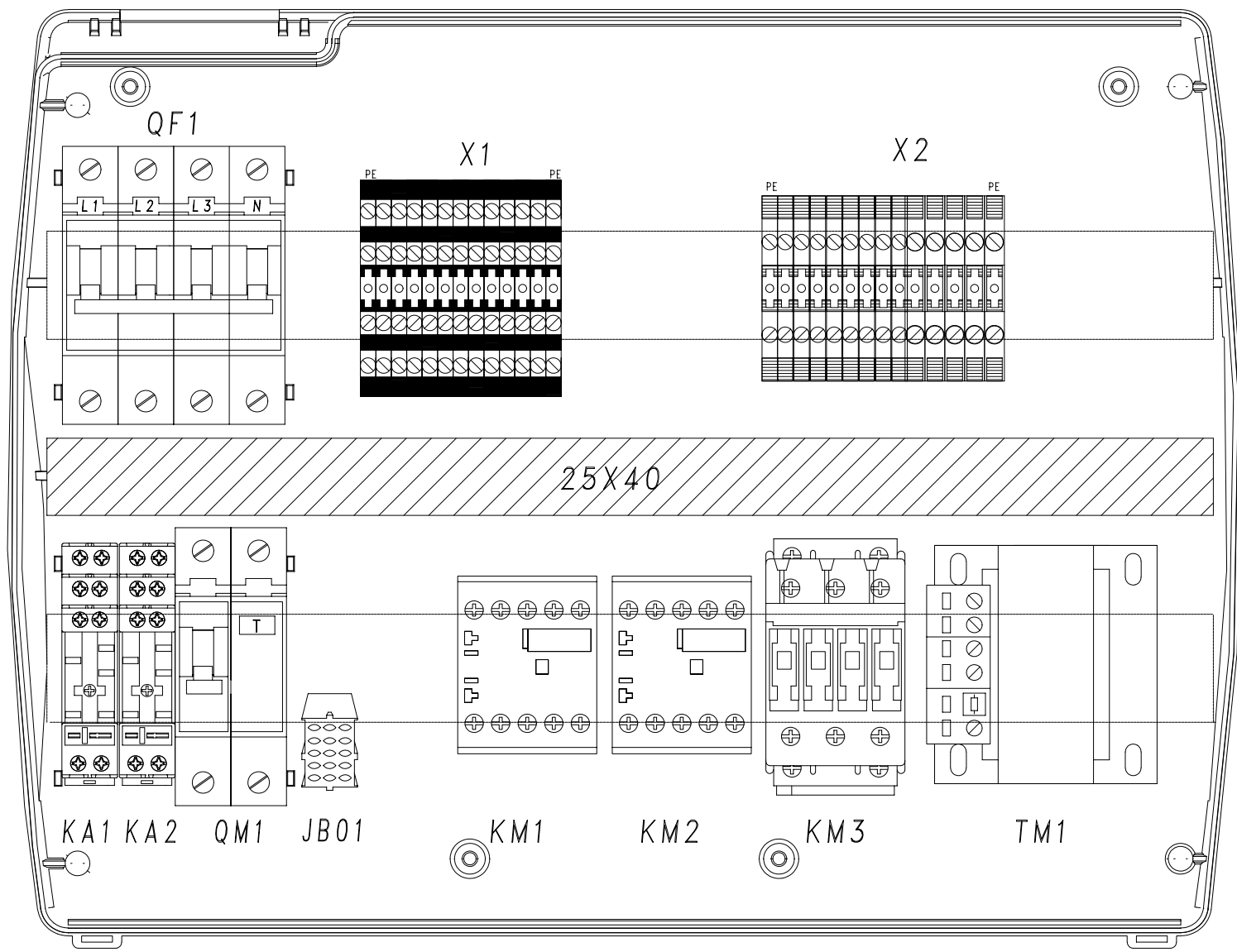

SIEMENS COMPONENT

COPYING OF THIS DOCUMENT, AND GIVING IT TO OTHERS AND THE USE OR COMMUNICATION OF THE CONTENTS THEREOF, ARE FORBIDDEN WITHOUT EXPRESS AUTHORITY. OFFENDERS ARE LIABLE TO THE PAYMENT OF DAMAGES. ALL RIGHTS ARE RESERVED IN THE EVENT OF THE GRANT OF A PATENT OF THE REGISTRATION OF A UTILITY MODEL OR DESIGN.

PROJECT: TTL300ExpertUVD12.sch
 FILE NAME: TTL300ExpertUVD12.sch
 TYPE:

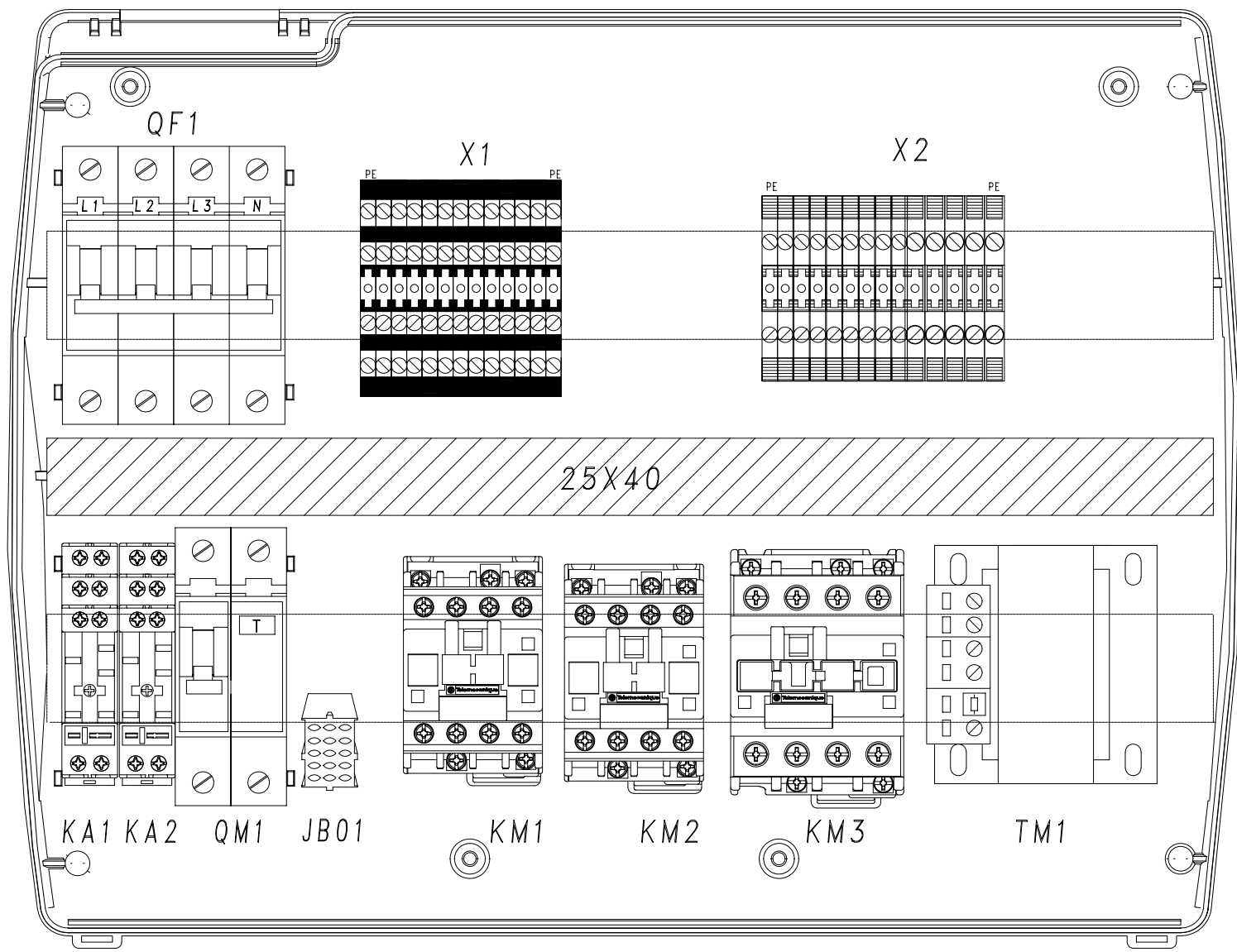

TELEMECANIQUE COMPONENT

DATE 30/03/2007
 COMMISS. Bonvicini
 CHECKED BY
 APPROV.

LAY OUT



TTL300 EXPERT U VD 12

= TTL300 EXPERT U VD 1
 +
 SHEET 8
 N.S. T.F. 9

1 2 3 4 5 6 7 8