

Installation guide – Spare parts and accessories

Inspection kit | Code number 027H3016
ICS, size 32 (1-3) / ICM, size 32 / ICLX, size 32

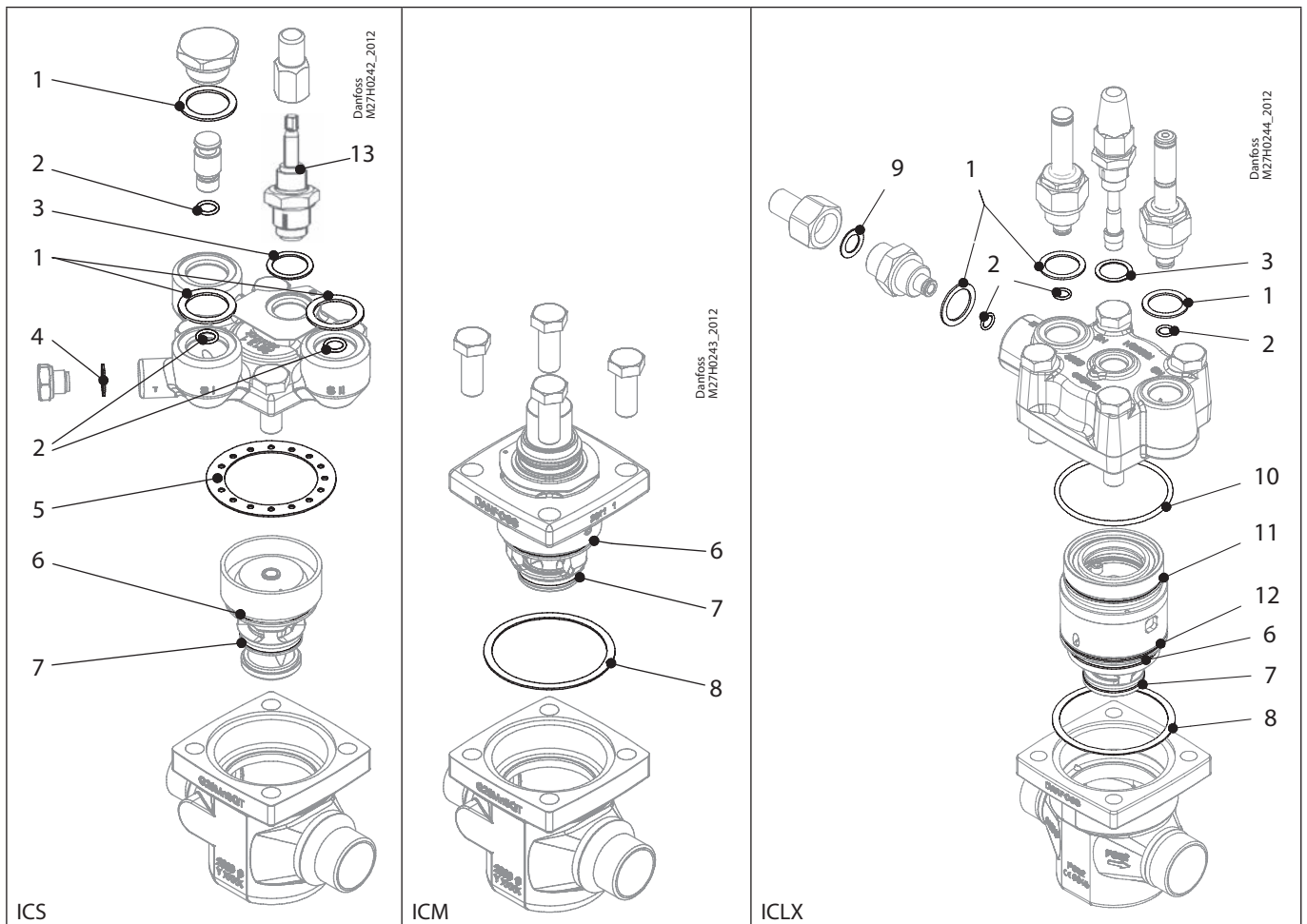

<p>1 = Fibre</p> <p>Total no. = 3</p>	<p>2 = Al.</p> <p>Total no. = 3</p>	<p>3 = Al.</p> <p>Total no. = 1</p>	<p>4 = Al.</p> <p>Total no. = 1</p>	<p>5 = Fibre</p> <p>Total no. = 1</p>
<p>6 = Al.</p> <p>Total no. = 1</p>	<p>7 = Al.</p> <p>Total no. = 1</p>	<p>8 = Fibre</p> <p>Total no. = 1</p>	<p>9 = Al.</p> <p>Total no. = 1</p>	<p>10 = Al.</p> <p>Total no. = 1</p>
<p>11 = Al.</p> <p>Total no. = 1</p>	<p>12 = Al.</p> <p>Total no. = 1</p>	<p>13 = Al.</p> <p>Total no. = 1</p>		