

OWNER'S & INSTALLATION MANUAL

Weekly-Timer Central Controller

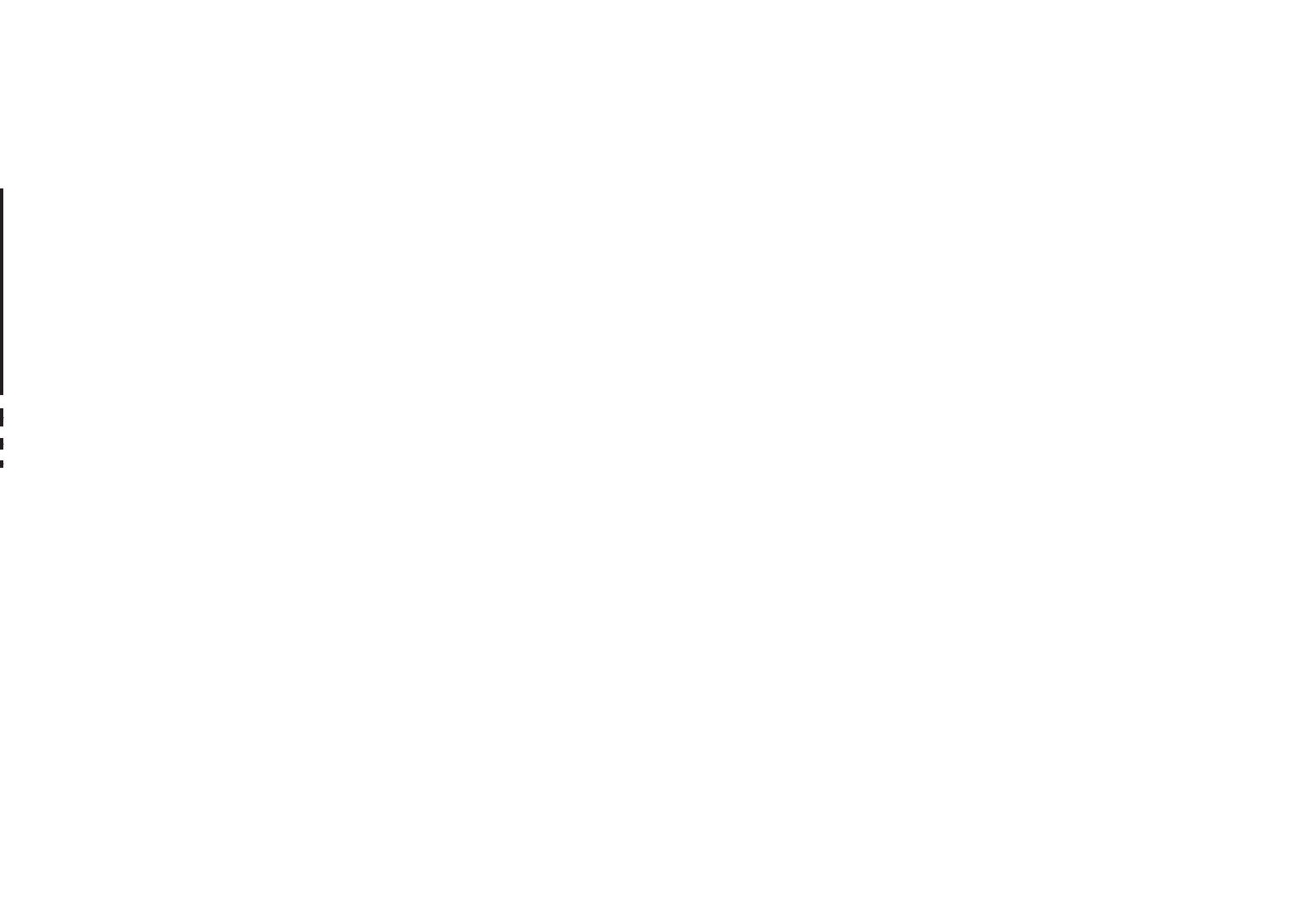

Please keep this specifications manual properly.
Read this specifications manual carefully before using the equipment.



Applicable model: WCRF-10-CM

CONTENTS

PAGE

1. SAFETY PRECAUTIONS.....	1
2. SYSTEM WIRING INSTRUCTIONS.....	2
3. ACCESSORY LIST AND ITEMS.....	3
4. INSTALLATION INSTRUCTIONS.....	4
5. INSTALLATION METHOD.....	4
6. INDICATOR DESCRIPTION OF THE WEEKLY-TIMER CENTRAL CONTROLLER.....	8
7. KEY DESCRIPTION OF THE WEEKLY-TIMER CENTRAL CONTROLLER.....	10
8. THE OPERATING FLOW DESCRIPTION OF THE WEEKLY-TIMER CENTRAL CONTROLLER.....	18
9. OTHERS.....	29
10. PROTECT CODE AND ERROR CODE TABLE.....	30
11. TECHNICAL INDICES AND REQUIREMENTS.....	32

1. SAFETY PRECAUTIONS

- Be sure to be in conformity with the local, national and international laws and regulations.
- Read "PRECAUTIONS" carefully before installation.
- The following precautions include important safety items. Observe them and never forget.
- Keep this manual with the owner's manual in a handy place for future reference.

The safety precautions listed here are divided into two categories. In either case, important safety information is listed which must be read carefully.



WARNING

Failure to observe a warning may result in death.



CAUTION

Failure to observe a caution may result in injury or damage to the equipment.

After completing the installation, make sure that the unit operates properly during the start-up operation. Please instruct the customer on how to operate the unit and keep it maintained. Also, inform customers that they should store this installation manual along with the owner's manual for future reference.



WARNING

Dealers or professional staffs shall be consigned to carry on installation, otherwise electric shock or fire accident may be caused by improper installation.

Conduct installation strictly according to this installation instruction. Improper installation may lead to electric shock or fire accident.

Reinstallation shall be conducted by professional staffs, otherwise electric shock or fire accident may be caused by improper installation.

Do not disassembly or assembly it randomly. Random disassembly and assembly may cause the abnormal operating and heating of the air conditioning system, thus leading to fire accident.



CAUTION

Do not install it in the place with the flammable gas leakage. Once the flammable gas leaks, the leakage will stay among the surrounding of the weekly timer and cause fire accident.

The wiring shall adapt to the current of weekly-timer central controller, otherwise it is easy to cause the leakage and heating, thus leading to fire accident.

2. SYSTEM WIRING INSTRUCTIONS

2.1 Connecting diagram for air-conditioning system with central network

■ Correct connecting diagram 1

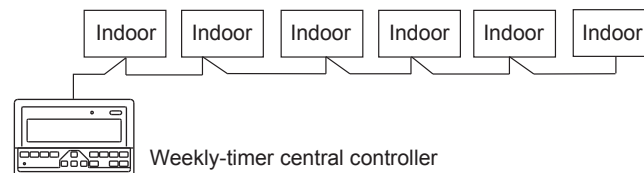

Fig.2-1

■ Correct connecting diagram 2

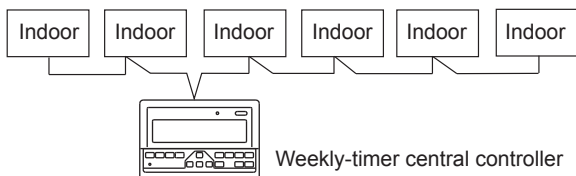

Fig.2-2

2.2 Other relevant explanation

(There are two kinds of indoor unit, namely indoor unit with built-in network module or external network module.)

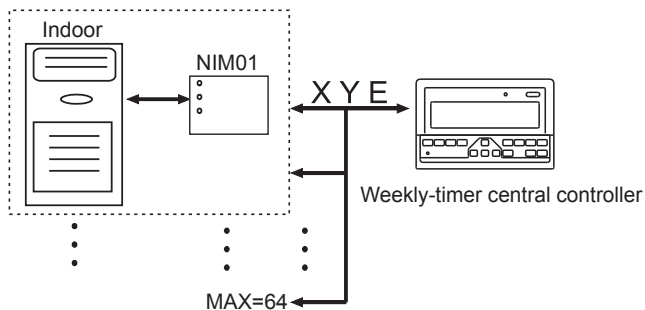

Fig.2-3

3. ACCESSORY LIST AND ITEMS

- The following is the packing list of the weekly-timer central controller. Confirm whether it contains all accessories.

Num	Name	Quantity	Remarks
1	Weekly-timer central controller	1	According to the applicable model
2	Cross recessed pan head tapping screw	6	GB845/ST3.9X25-C-H(S)
3	Plastic expansion tube	6	Φ6X30
4	Installation and operating instructions	1	This manual
5	Matching resistor	2	120Ω

- Field installation accessories prepared

Num	Name	Quantity	Model selected	Remarks
1	Three-core shielded cable	1	RVVP-300/300 3×1mm ²	Used for communicating with the indoor unit of the air conditioning system
2	Three-core cable	1	RVV-300/500 3×1.5mm ²	Used for the supplying power to the weekly-timer central controller
3	Switch case	1	_____	_____
4	Cable tubes (plug sleeve, anti-loosening screw)	3	_____	_____
5	Cable tie	several	_____	Used for binding cable (according to the specific situation)

4. INSTALLATION INSTRUCTIONS

4.1 Installation instructions to the central controller:

1. Be sure to connect the power supply wiring to the power supply terminal block.
2. When running power supply and transmission wires parallel to each other, run them through separate conduits or maintain a suitable distance between them.
3. Transmission wiring should be done within the following limitation. If they are exceeded, transmission problems may occur.
Max. wiring length: 1,200 m or 3,940 ft.
4. Make sure there is no joint in the middle of the shielded cable. If such a joint exists, use a socket to connect it.
5. After finishing the connection of the Weekly-timer central controller, do not use megger to check the insulation of the signal cable.
6. Connecting mode between the Weekly-timer central controller and network interface:

The communication port between the central controller and the network interface of the air conditioning system is polar. The X, Y, and E pins on both sides shall be corresponding

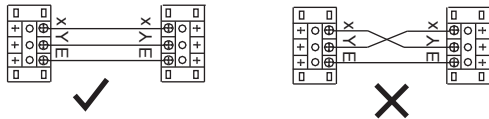

Fig.4-1

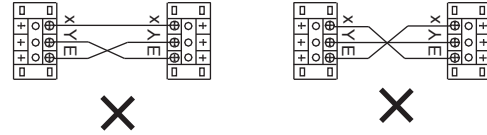

Fig.4-2

5. INSTALLATION METHOD

5.1 The installation method of the central controller using electrician switch case.

The thickness of the central controller cable shall be adjusted according to the length of the cable. A proper cable tube shall be used to install the cable of the central controller. Insert the flat tip screwdriver into the recess on the top panel of the case and slightly turn to open the top cover of the central controller.

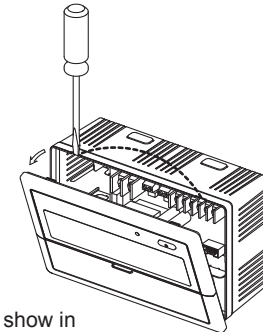

Fig.5-1

Note:
The installation procedure show in Fig.5-1 ~ Fig.5-5 is for structure 1

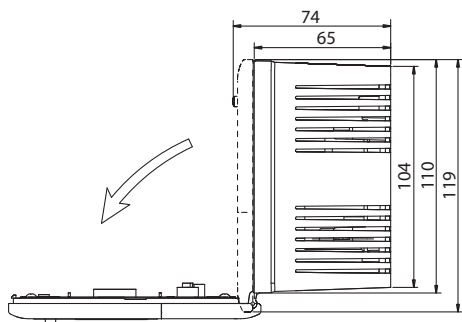

Fig.5-2

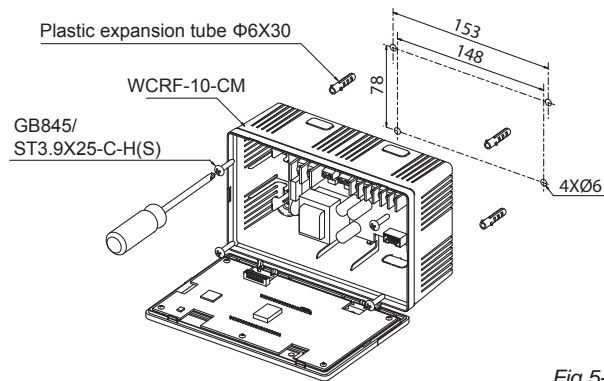

Fig.5-4

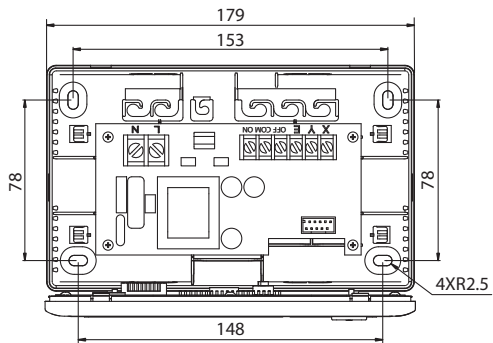

Fig.5-3

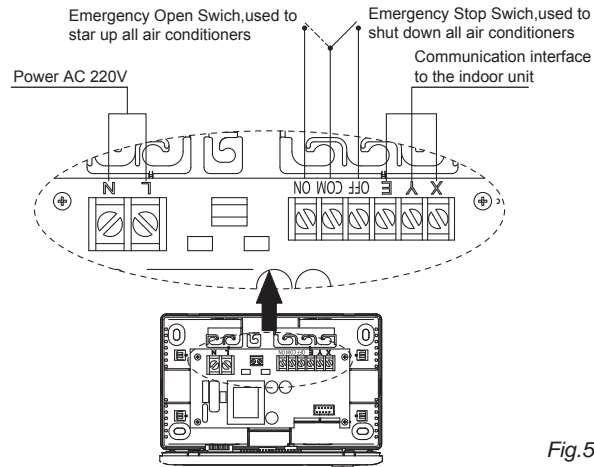
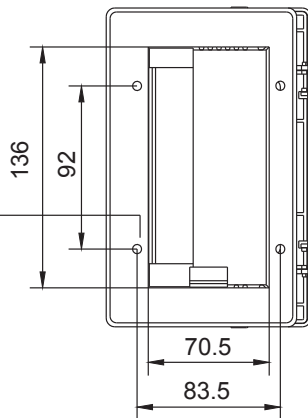

Fig.5-5

Installation dimensions:
As shown in the figure
on the right side.

Installation screw
holes (4 holes)



Note:
The installation procedure show in
Fig.5-6 ~ Fig.5-8 is for structure 2

Fig.5-6

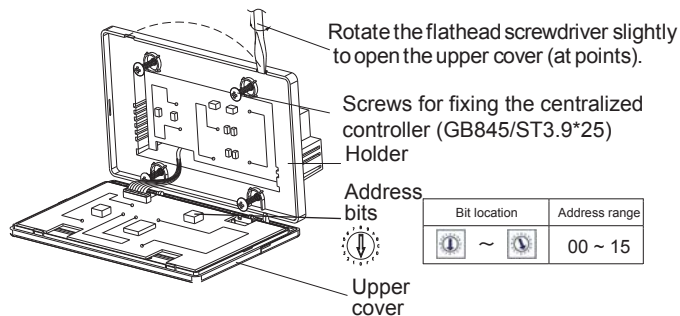

Bit location	Address range
~	00 ~ 15

Fig.5-7

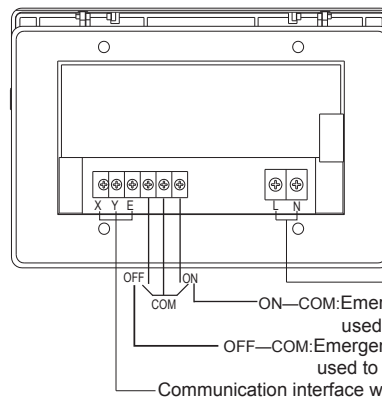

(Fig.5-8)

Power connector of the
central controller 220V/AC

ON—COM:Emergency open switch,
used to start up all air conditioners.

OFF—COM:Emergent stop switch,
used to shut down all air conditioners.

Communication interface with indoor interface

5.2 Connecting diagram of network-based air conditioning system

(There are two types of indoor units, namely indoor unit with external network interface module on the main control board or built-in network interface module in the main control board.)

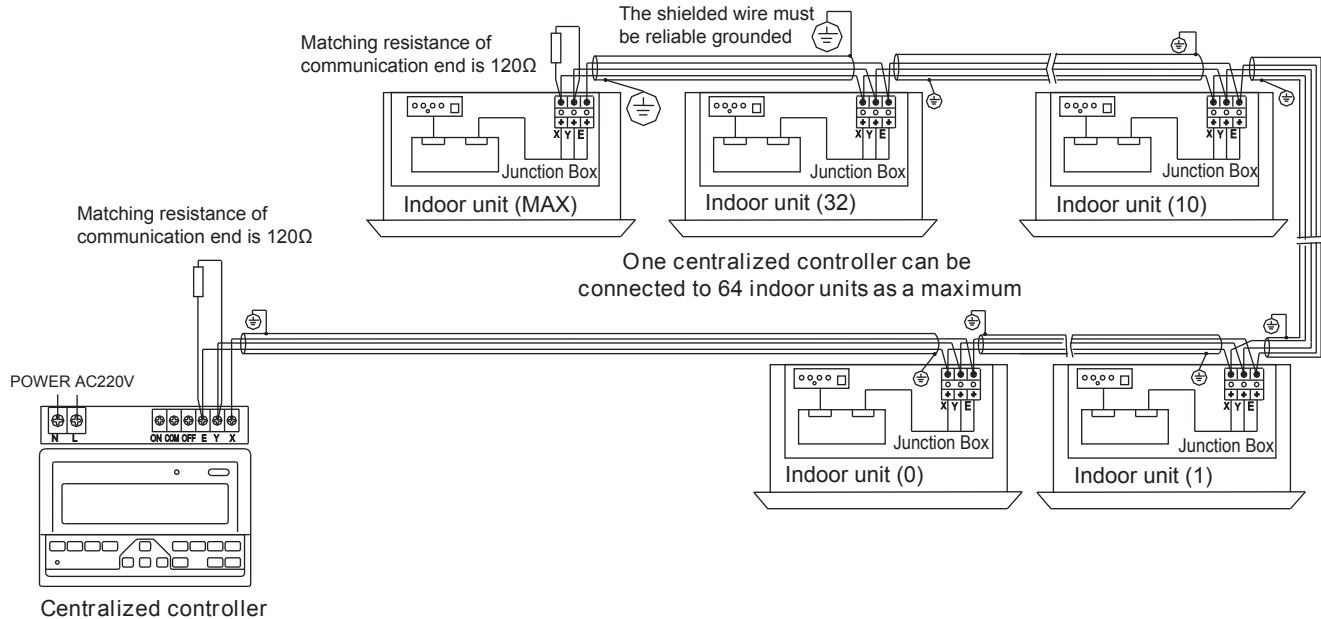

Fig.5-8

6. INDICATOR DESCRIPTION OF THE WEEKLY-TIMER CENTRAL CONTROLLER

6.1 General drawing of the liquid crystal display of the weekly-timer central controller

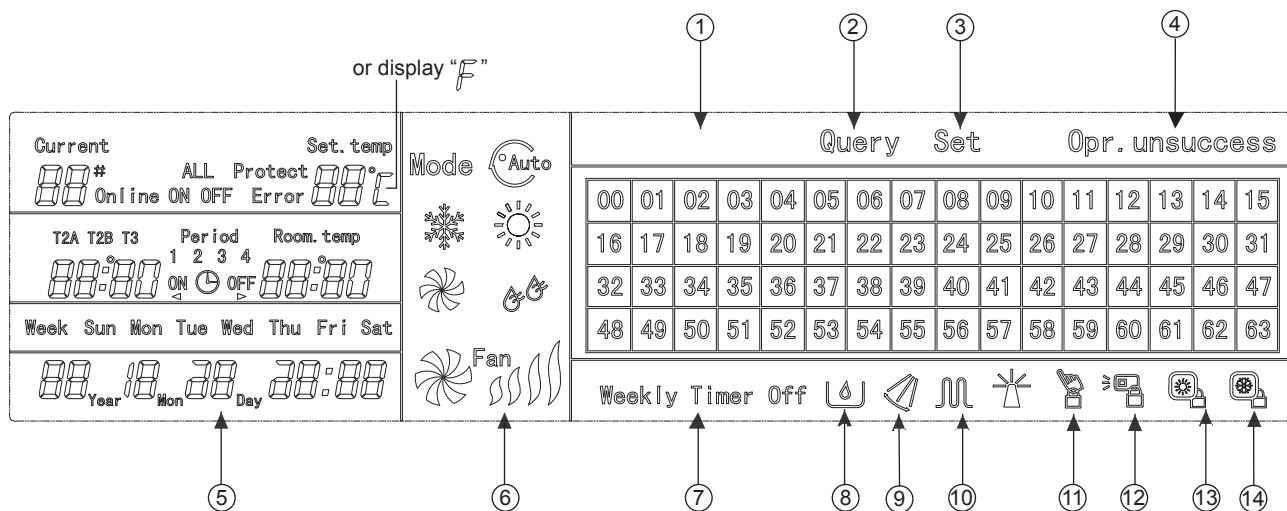

Fig.6-1

①	On-line condition matrix table of air conditioners 0-63
②	Query
③	Set
④	Operate result
⑤	Date Time
⑥	Run Mode:Auto Cool Heat Fan Dry Fan Speed
⑦	Weekly-Timer Off

⑧	Economy Run
⑨	Swing
⑩	Electric Auxiliary Heater
⑪	Locking:All buttons disabled except Lock button.
⑫	Remote controller Locking: remote controller disabled.
⑬	Locking to heating mode:only heating mode effective.
⑭	Locking to cooling mode:only cooling mode effective.

6.2 LCD icon description of the weekly-timer central controller

Table.6-1











Icon	Meaning	Icon	Meaning
	Automation Mode		Fan Only Mode
	Cool Mode		Dry Mode
	Heat Mode		Fan speed High/Middle/ Low/Auto
	Electric Auxiliary Heater		Lock Heat
	Lock Cool		Lock Remoter
	Lock Keyboard	Set	Setting
Query	Querying	Opr. unsuccess	Operate Result
Weekly Timer Off	Weely Timer Off	ALL	All

Table.6-2

Icon	Meaning	Icon	Meaning
Online	Online	Protect	Protecting
Error	Error	Set. temp	Set Temperature
Period 1 2 3 4	Period1,2,3,4	Room. temp	Room Temperature
T2A T2B T3	T2A: Indoor pipe Temperature A T2B: Indoor pipe Temperature B T3: Outdoor pipe Temperature	Mon	Monday
Tue	Tuesday	Wed	Wednesday
Thu	Thursday	Fri	Friday
Sat	Saturday	Sun	Sunday

7. KEY DESCRIPTION OF THE WEEKLY-TIMER CENTRAL CONTROLLER

7.1 General key layout of the weekly-timer central controller

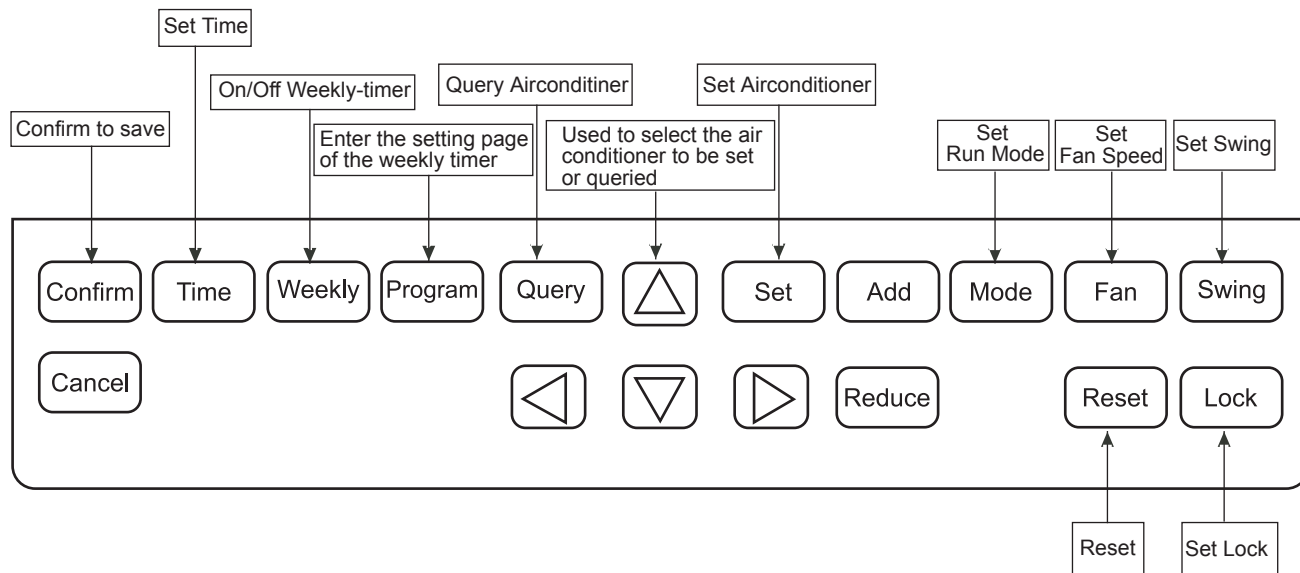

Fig.7-1

7.2 Key instructions of the weekly-timer central controller

Table.7-1













KEY NAME	USAGE
	<p>Press the ON/OFF button. All air conditioners will be shut down if they are running, on the contrary, they will be started up. If you press the button for less than 5 seconds, the startup mode is the last running mode of the air conditioner. If you press the button for more than 5 seconds, the startup mode is cooling, high Speed, 24 degrees.</p>
	<p>Press the "SET" button, and then select "set single" or "set all". "set single" indicates to set the parameter (such as mode/ temperature/ Fan speed/ weekly timer) of an selected air conditioner. "set all" indicates to set the parameter of all air conditioners controlled by the central controller.</p>
	<p>Press the "query" button to query the running condition of the air conditioner, such as on/off, temperature setting, indoor temperature, running mode and Fan speed. Press "up", "down", "Left" and "right" to select the air conditioner that you want to query.</p>
	<p>When querying or setting the indoor unit, press the "up" to select the indoor unit to be set or queried.</p>
	<p>When querying or setting the indoor unit, press "down" to select the indoor unit that you want to set or query.</p>
	<p>When querying or setting the indoor unit, press "Left" to select the indoor unit to be set or queried. In setting the weekly timer, it is used for selecting the day of the week and the time of startup and shutdown.</p>
	<p>When querying or setting the indoor unit, press "right" to select the indoor unit to be set or queried. In setting the weekly timer, it is used for selecting the day of the week and the time of startup and shutdown.</p>
	<p>When querying the indoor unit, press the "Add" button to query more parameter of the indoor unit. In setting the indoor unit, it is for modifying the setting temperature. In setting the weekly timer, it is for modifying the time of startup and shutdown.</p>

Table.7-2

KEY NAME	USAGE
<div style="border: 1px solid black; border-radius: 10px; padding: 5px; width: fit-content; margin: 0 auto;">Reduce</div>	<p>When querying the indoor unit, press the “Reduce” button to query more parameter of the indoor unit. In setting the indoor unit, it is for modifying the setting temperature. In setting the weekly timer, it is for modifying the time of startup and shutdown.</p>
<div style="border: 1px solid black; border-radius: 10px; padding: 5px; width: fit-content; margin: 0 auto;">Mode</div>	<p>In setting the indoor unit, it is used for setting the running mode of the indoor unit which includes Automation, Cool, Heat, Fan Only, Dry and Off. You can select among them.</p>
<div style="border: 1px solid black; border-radius: 10px; padding: 5px; width: fit-content; margin: 0 auto;">Fan</div>	<p>In setting the indoor unit, it is for setting the wind speed of the indoor unit which includes high speed, middle speed, low speed and automatic speed. You can select one among them.</p>
<div style="border: 1px solid black; border-radius: 10px; padding: 5px; width: fit-content; margin: 0 auto;">Swing</div>	<p>In setting the indoor unit, it is for setting the swing-function of the indoor unit. The running mode is selected between “swing-on” and “swing-off”.</p>
<div style="border: 1px solid black; border-radius: 10px; padding: 5px; width: fit-content; margin: 0 auto;">Lock</div>	<p>When setting, press the “Lock” button to lock the remote controller of all or single indoor unit. Press the “Query” button and hold under the main page, then repress the “Lock” button again to lock the keyboard of the central controller; press the “Mode” button and then repress the “Lock” button to lock the running mode.</p>
<div style="border: 1px solid black; border-radius: 10px; padding: 5px; width: fit-content; margin: 0 auto;">Reset</div>	<p>The central controller re-scans the indoor unit in the network as recharging after power off.</p>
<div style="border: 1px solid black; border-radius: 10px; padding: 5px; width: fit-content; margin: 0 auto;">Program</div>	<p>Under the main page, press the “Program” button to set the weekly timer of “single indoor unit” or “all indoor units”. Press the “Query” button and hold, and then press the “Program” button to query the weekly timer parameters of the indoor unit.</p>

Table.7-3

KEY NAME	USAGE
	<p>Under the main page, press the “Weekly” button to start up or shut down the weekly timer function.</p>
	<p>Under the main page, press the “Time” button for 5 seconds to enter the time-modifying status, and then press “Add” or “Reduce” button to modify the time. Press “Left” or “Right” to select minute/ hour/ day/ month/ year. Finally, press the “Confirm” button to save the modification.</p>
	<p>Save data and send the command required to the indoor unit, such as setting the mode of the air conditioner.</p>
	<p>Cancel the last operation and return to the last interface.</p>

7.3 The main interface of the weekly-timer central controller (user interface)

- 1) Under the other pages, press to return to the main interface.
- 2) Under the other pages, automatically return to the main interface when no operation for a period of time.
- 3) The main interface displays the on-line condition of the indoor unit.

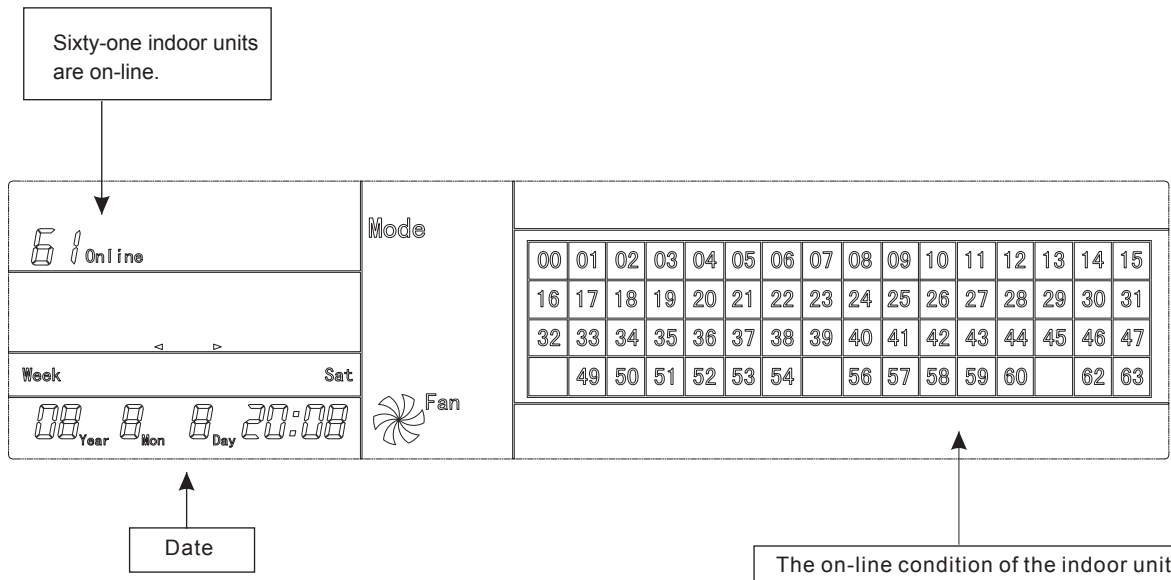

Fig. 7-2

7.4 Setting interface of single weekly-timer central controller

- 1) Under the main interface, press **Set** to select to the single setting interface
- 2) Automatically return to the main interface when no operation for a period of time.
- 3) Set the running status of single air conditioner under this page.

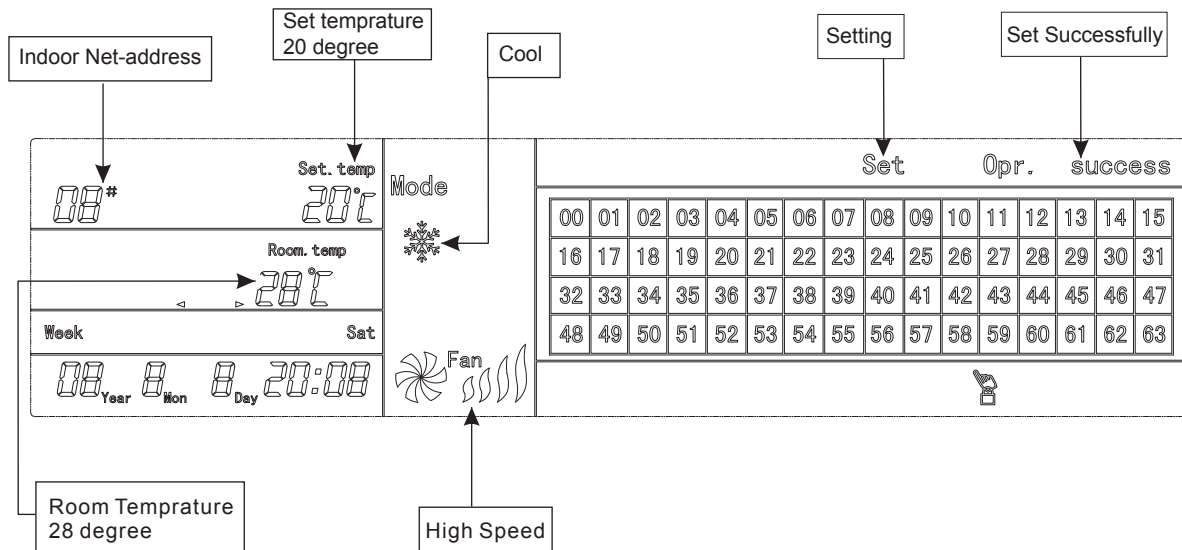

Fig.7-3 with Centigrade “°C”

7.5 Setting interface of weekly timer parameters of single weekly-timer central controller

- 1) Under the main interface, press **Program** to display the parameter setting interface of single weekly timer.
- 2) Automatically return to the main interface if no operation is performed for a period of time.
- 3) Under this page, set the weekly timer parameters of single air conditioner, including startup time, shutdown time, the running mode of this period, temperature and wind speed.
- 4) One air conditioner can be at most set with four periods in one day from Monday to Sunday, seven days in total.

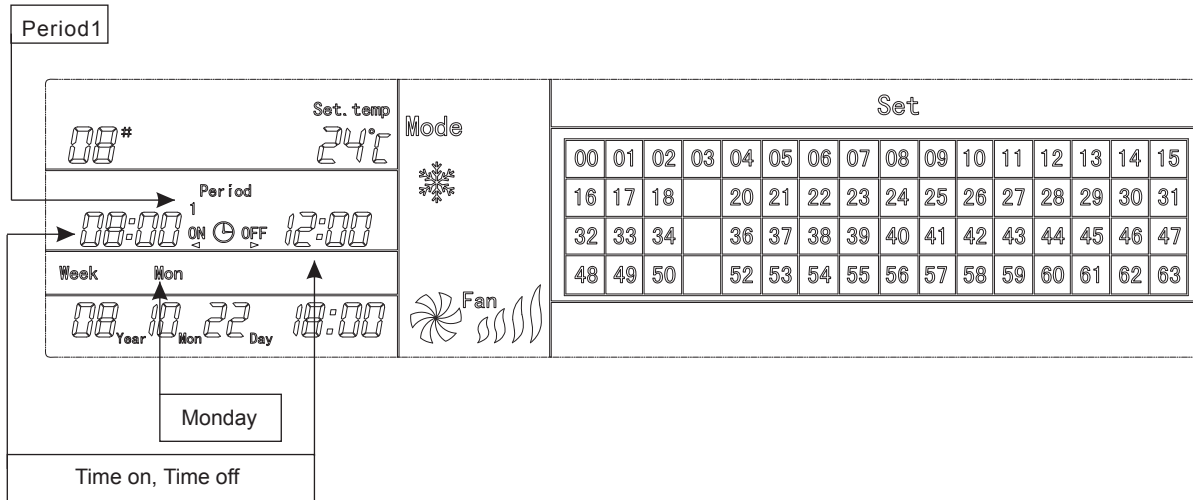

Fig.7-4 with Centigrade “°C”

7.6 Unified setting interface of the weekly-timer central controller

- 1) Under the main interface, press to display the unified setting interface.
- 2) Automatically return to the main interface if no operation is performed for a period of time.
- 3) Set the running mode of all air conditioners under this page, including mode, temperature and Fan speed.

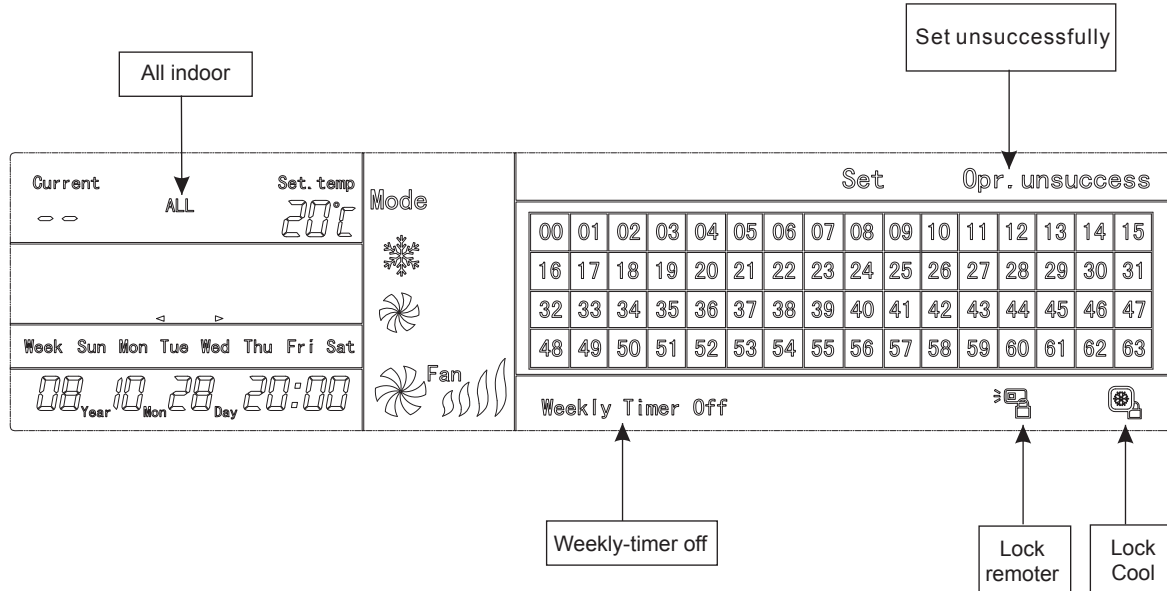

Fig.7-5 with Centigrade "°C"

8. THE OPERATING FLOW DESCRIPTION OF THE WEEKLY-TIMER CENTRAL CONTROLLER

8.1 How to set the running status of the air conditioner?

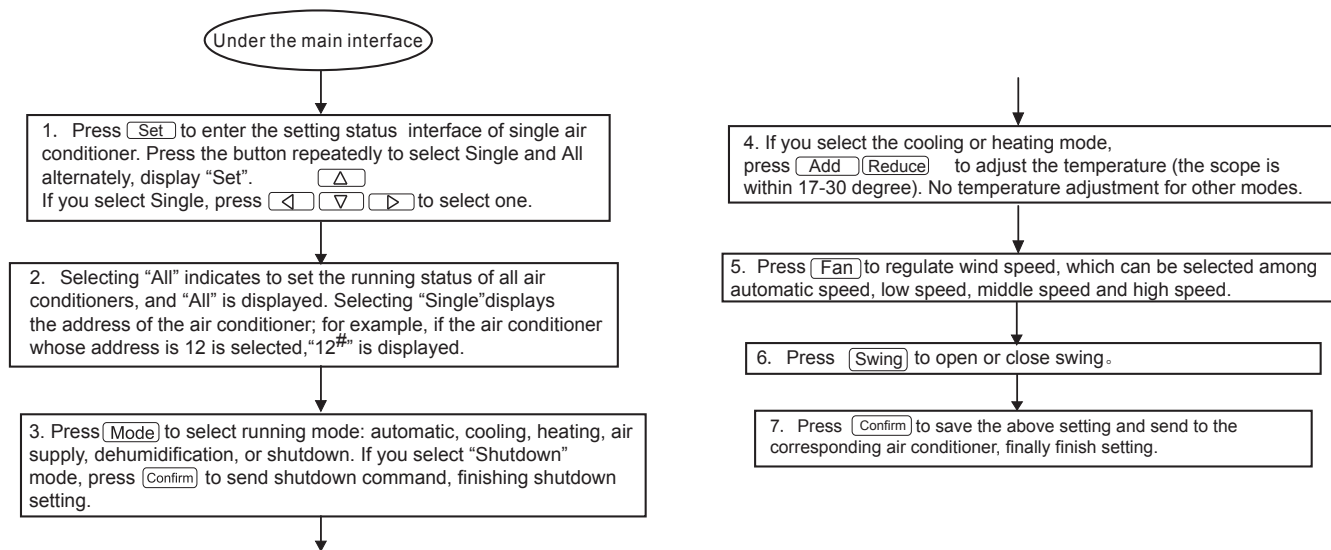

Fig.8-1

8.2 How to query the running status of the air conditioner?

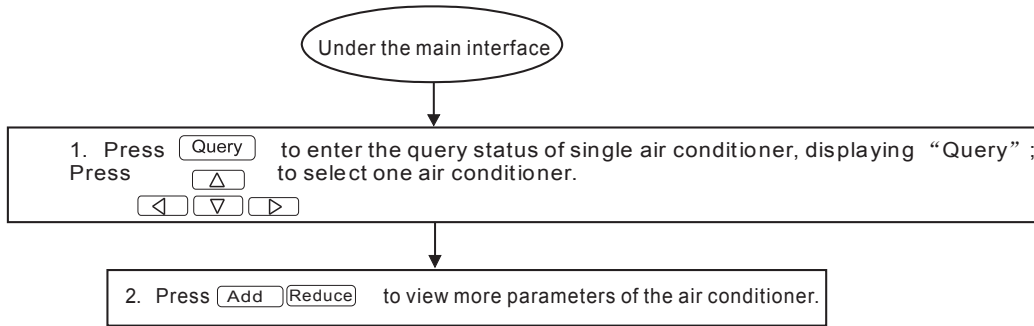

Fig.8-2

8.3 How to lock and unlock the remote controller of the air conditioner?

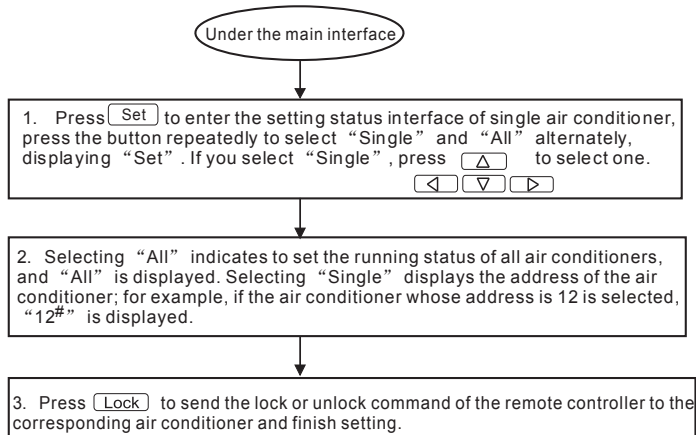

Fig.8-3

8.4 How to lock and unlock the mode of the air conditioner?

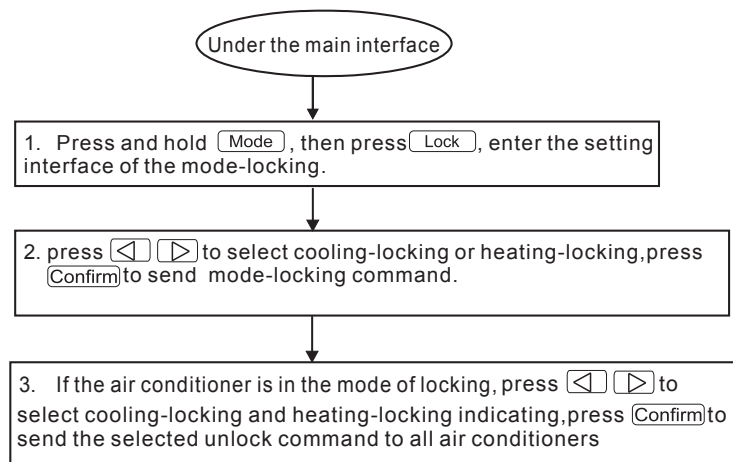

Fig.8-4

8.5 How to lock and unlock the keyboard of the weekly-timer central controller?

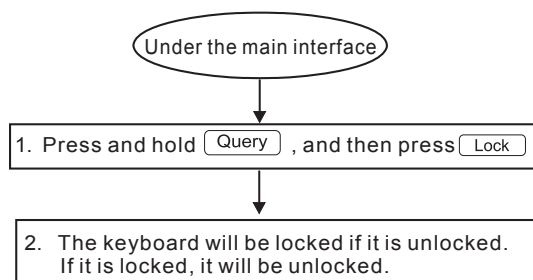

Fig.8-5

8.6 How to set the function and relevant parameters of the weekly timer of the air conditioner?

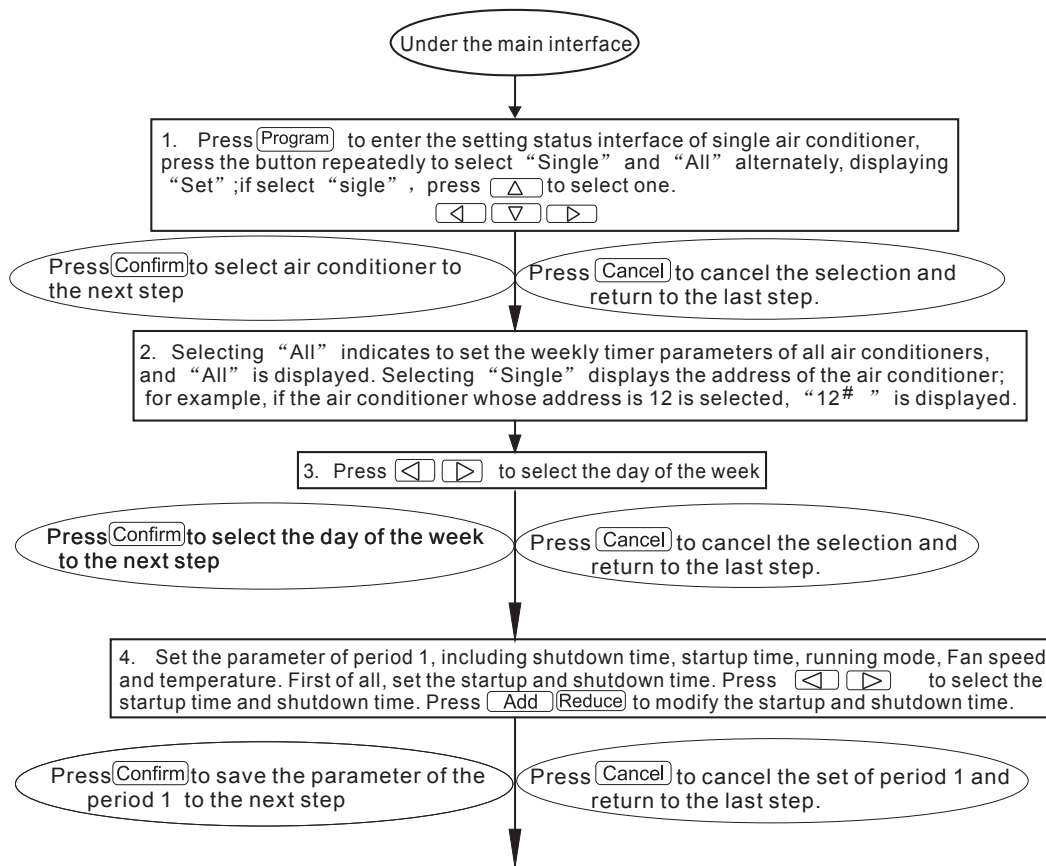

Fig.8-6.1

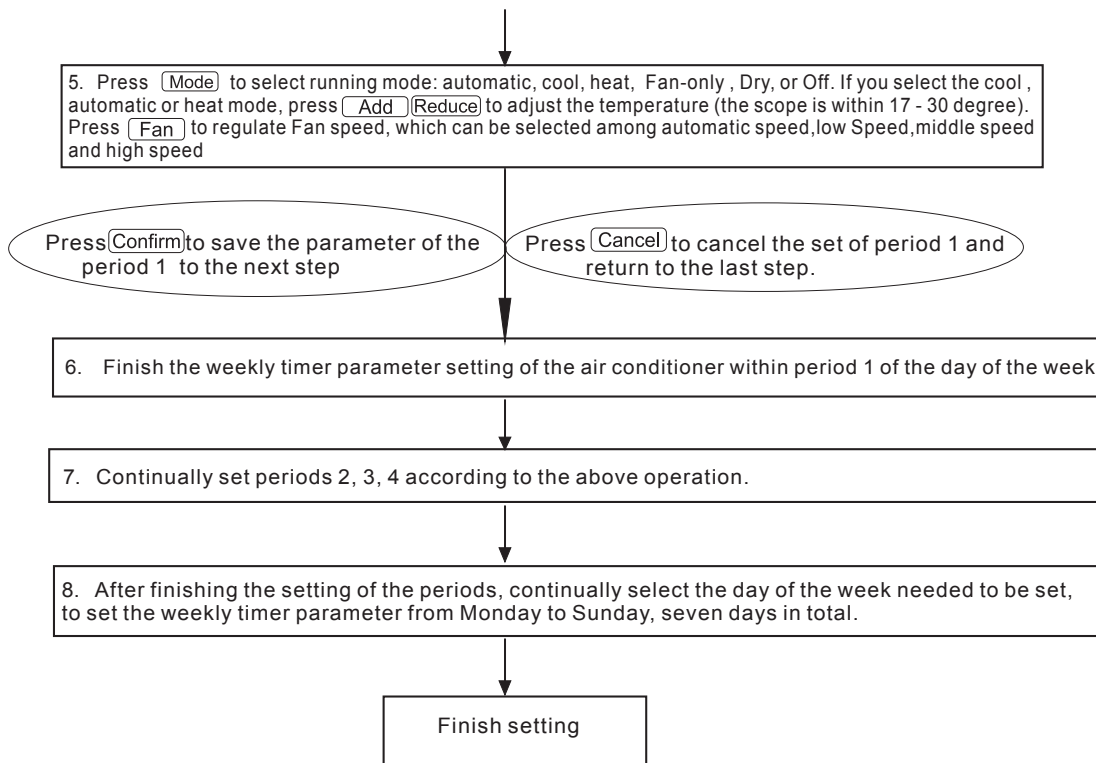

Fig.8-6.2

8.7 How to close the weekly timer setting of a period of an air conditioner?

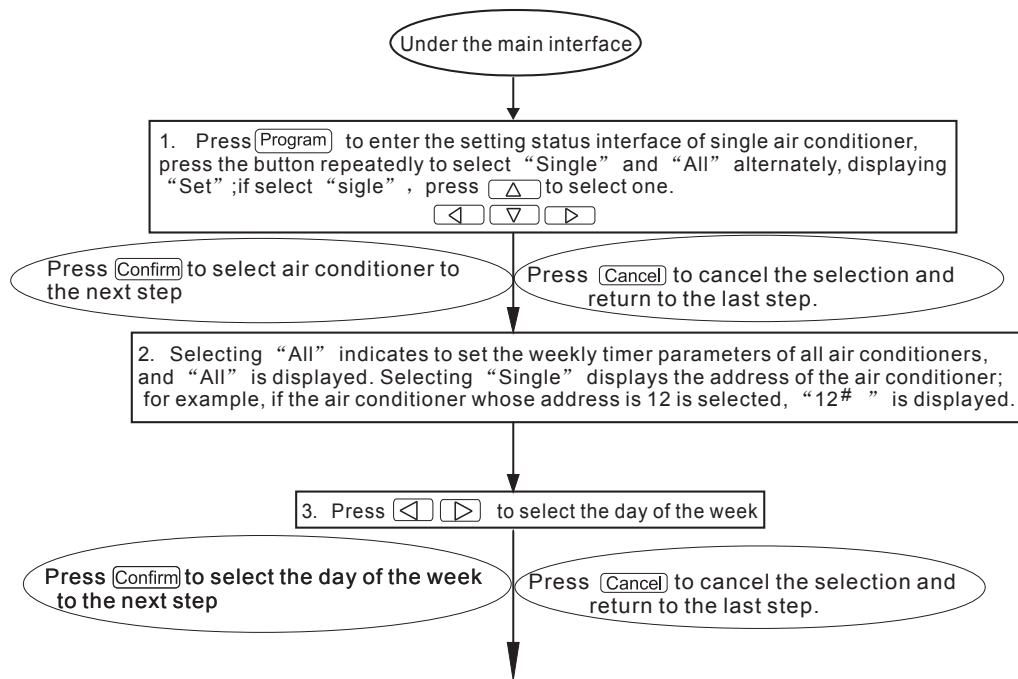

Fig.8-7.1

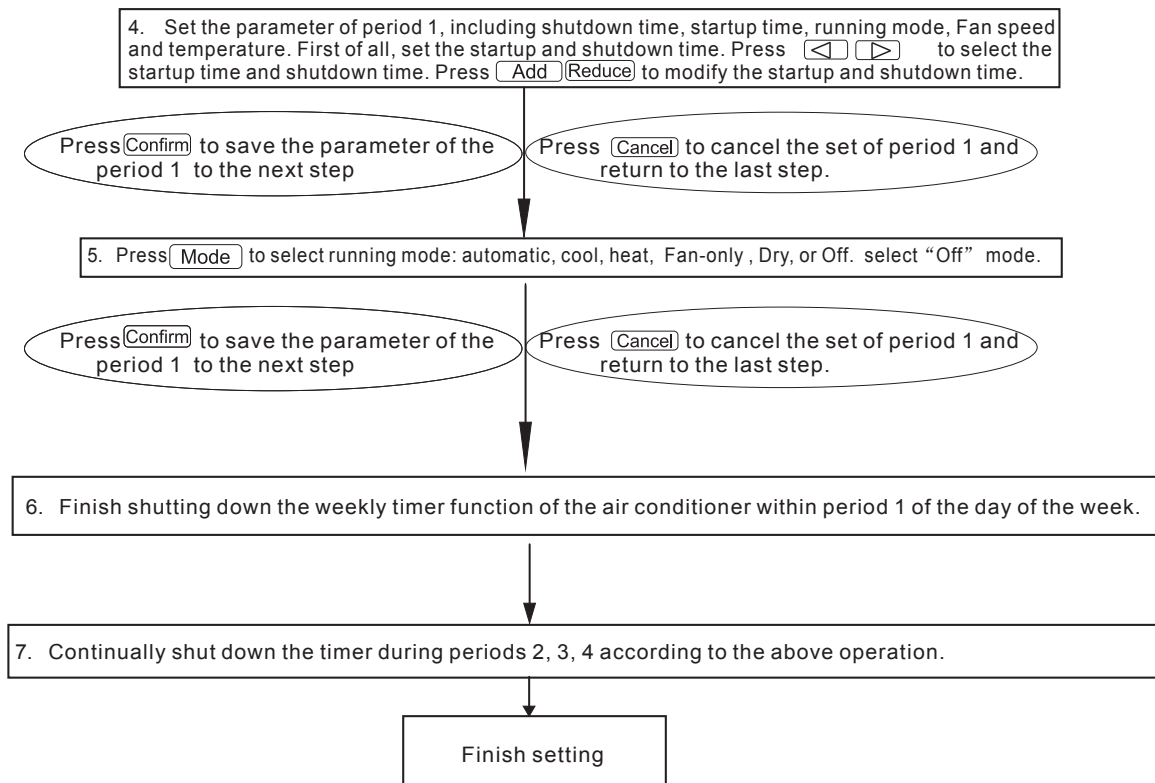

Fig.8-7.2

8.8 How to query the weekly timer setting parameter of the air conditioner?

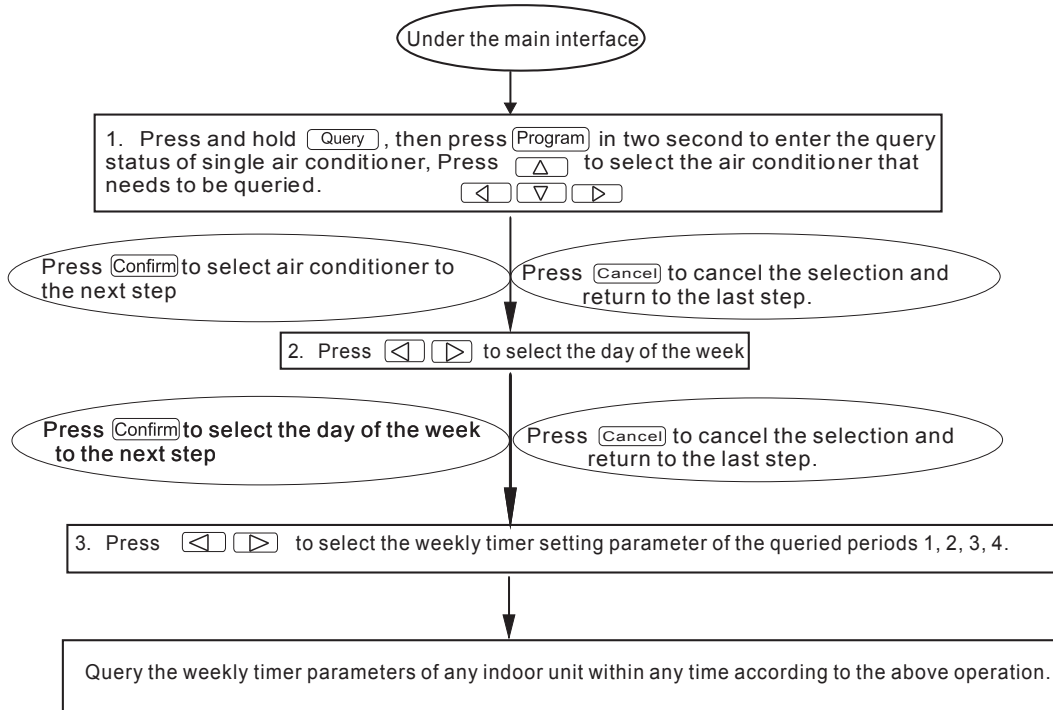

Fig.8-8

8.9 How to start up or shut down the weekly timer function of all air conditioners?

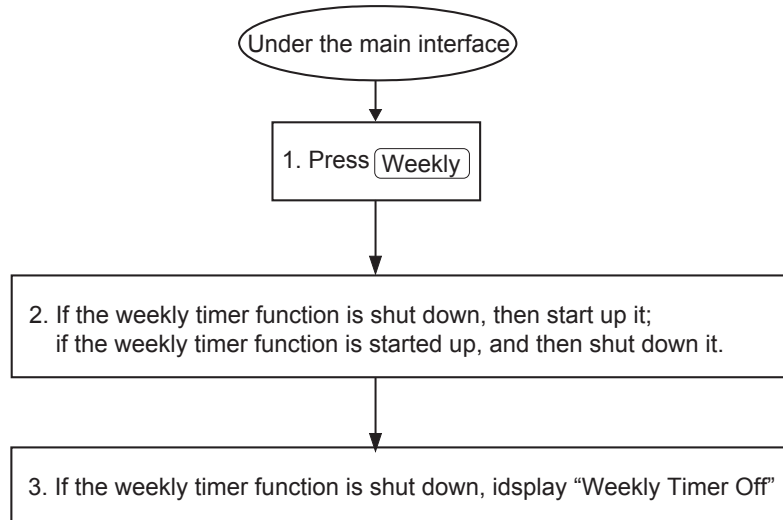

Fig.8-9

8.10 How to modify the system time?

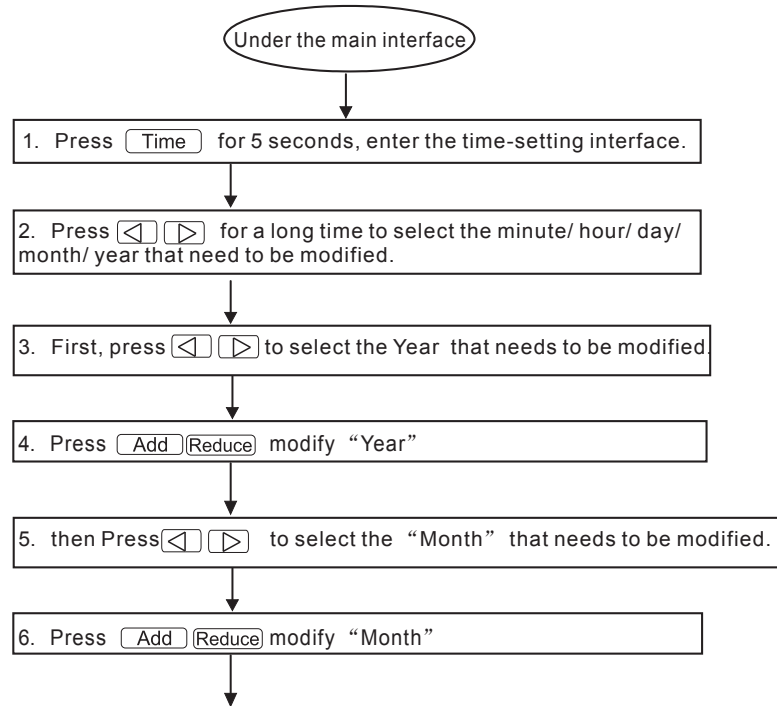

Fig.8-10.1

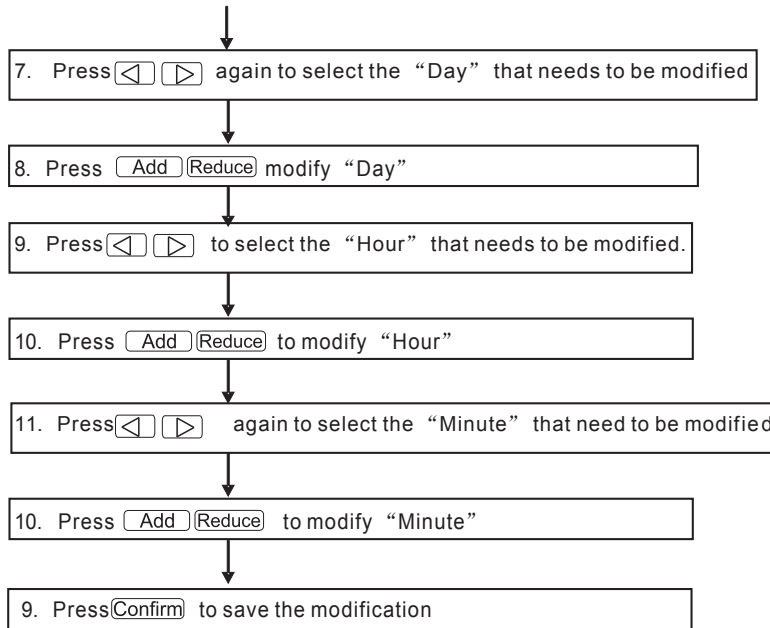

Fig.8-10.2

9. OTHERS

9.1 An example to show the function of the weekly timer

1) Take the indoor unit of the air conditioner with an address “04” for example, set the weekly timer parameters and start up the weekly timer function according to the above operation. The specific setting parameter is as shown in the table below:

Table.9-1

	Period 1	Period 2	Period 3	Period 4
Monday	Time on =07:30 Time off =18:00 Mode = cool Temp = 24 Fan = High	Time on =18:30 Time off =21:00 Mode= Fan-only Temp = Fan = High	Time on =21: 30 Time off =23: 30 Mode = cool Temp = 24 Fan = High	
Tuesday	Time on =07:30 Time off =18:00 Mode = cool Temp = 24 Fan = Low	Time on =18:30 Time off =19:00 Mode = Off Temp = Fan =		

From the above table, we can see that the indoor unit has been set weekly timer parameters for two days every week, namely period 1, 2, 3 of Monday and period 1 of Tuesday. If the weekly timer function is started up, the air conditioner will run according to the corresponding period setting when it is within the specific period.

Notes to the parameter of period 1 of Monday: The startup time is 07:30 and shutdown time is 18:30. The running mode is cool with 24 degree and high Speed.

If the air conditioner is running within the set period of the weekly timer and there is other control device to control the air conditioner, the air conditioner will run according to the set parameter of the control devices (such as remote controller, line controller and weekly-timer central controller) till to the next set period of the weekly timer.

If the set mode of a period of the air conditioner is Off, it means the weekly timer function of the period is invalid. For example, the set mode of period 2 of Tuesday is Off, which shows that the set weekly timer function of the period is invalid.

10. PROTECT CODE AND ERROR CODE TABLE

Table.10-1

Code	Content
EF	Other faults
EE	Water-level detection fault
ED	Fault protection of the outdoor unit
EC	Freshness fault
EB	Inverter module protect
EA	Excess flow of compressor (four times)
E9	Communication fault between main board and display board
E8	Losing control of wind speed examination
E7	EEPROM error
E6	Zero-crossing detection error
E5	Exhaust temperature sensor faulty of T3 or T4 or digital compressor
E4	T2B sensor fault
E3	T2A sensor fault
E2	T1 sensor fault
E1	Communication fault
E0	Phase-sequence error or phase-failure
07#	
06#	
05#	
04#	
03#	
02#	
01#	Communication fault between the central controller and the network interface module
00#	Communication fault between the network interface module and the main control board

Table. 10-2

Code	Content
PF	Other protection measures
PE	Reserved
PD	Reserved
PC	Reserved
PB	Reserved
PA	Reserved
P9	Reserved
P8	Excess flow of compressor
P7	Over-voltage or under-voltage protection
P6	Low-voltage protection of air exhaust
P5	High-voltage protection of air exhaust
P4	Temperature protection of exhaust pipe
P3	Temperature protection of compressor
P2	High temperature protection of condenser
P1	Cold air-proof or defrosting-proof protection
P0	Temperature protection of evaporator

11. TECHNICAL INDICES AND REQUIREMENTS

- EMC comply with the CE certification requirements.

12. BASIC CONDITIONS OF OPERATING THE WEEKLY CENTRALIZED CONTROLLER

12.1 Applicable range of supply voltage:

Input voltage: Single-phase 220V-240V;
AC input power supply frequency: 50Hz/60Hz.

12.2 Operating Conditions:

Environment temperature: -15°C~+43°C(+5°F~+109°F).
Environment Relative Humidity: RH40%~RH90%.

202055100944